

Linear

Audio, Video & Data Solutions



Pre-Wiring Design Guide

High-Definition Video Distribution Components

Audio/Video Distribution Systems

RF Distribution Amplifiers

Audio/Video Modulators

Data, Telephone & Video Distribution Modules

Structured Wire Intercom Components

RF Splitters, Filters & Accessories

Infrared Remote Controls

Structured Wiring Enclosures

Structured Wiring Accessories

Total Access Port Wall Plates

Music Distribution Systems

4-Ohm Speakers

8-Ohm Speakers

Speaker Rough-In Mounting Rings

Audio Wall Plates, Speaker & Volume Controls

Audio/Video Distribution Accessories

Application Diagrams

Reference Section

Glossary of Terms

Linear Audio / Video / Data Solutions

An Innovative History



Linear was established in 1961 as a manufacturer of radio controls. Over the next four decades, an unrelenting dedication to quality has turned it into the most trusted name in everyday technology.

Long known for pioneering radio frequency in everyday use, Linear now combines passive infrared detection, digital electronics, and human engineering for a full range of products. Today, Linear opens your gates, your garages, and your front doors. You walk through Linear. You talk through Linear. You trust Linear every day.

Linear's prevalence across America is simply unprecedented. Hundreds of thousands of people use Linear products every day without even knowing it. Backed by the industry's best warranties, a network of qualified integrators and installers, and unrivaled electronic solutions know-how, it's no wonder that Linear continues to lead the industry forward.

Linear combines the latest in technology with simplicity and elegance. From gate operators to intercom systems to high-definition video distribution, these are innovations that are designed to make your life easier. These are innovations that make your life better.

Linear Audio / Video / Data Solutions

Order Info

Sales Department:

5:00 AM — 4:30 PM (Pacific Time) Monday through Friday.

By Phone: 1 800 421 1587
By Fax: 1 800 468 1340
By Web: linearcorp.com
By Email: sales@linearcorp.com

Technical Support for Dealers & Installers:

5:00 AM — 4:30 PM (Pacific Time) Monday through Friday.

By Phone: 1 800 421 1587
By Fax: 1 760 438 7199
By Web: linearcorp.com
By Email: techsupport@linearcorp.com

These Linear products are available nationwide at hundreds of conveniently located local distributor branches. These innovative products are available where you need them and when you need them, making Linear the natural choice for your audio/video/data solutions.

Linear Audio / Video / Data products are distributed by:

All these brands are now under the Linear name.



Contents

Pre-Wiring Design Guide	02 – 05
High-Definition Video Distribution Components	06 – 13
Audio/Video Distribution Systems	14 – 14
RF Distribution Amplifiers	15 – 17
Audio/Video Modulators	18 – 24
Data, Telephone & Video Distribution Modules	25 – 28
Structured Wire Intercom Components	29 – 32
RF Splitters, Filters & Accessories	33 – 35
Infrared Remote Controls	36 – 37
Structured Wiring Enclosures	38 – 40
Structured Wiring Accessories	41 – 42
Total Access Port Wall Plates	43 – 43
Music Distribution Systems	44 – 49
4-Ohm Speakers	50 – 50
8-Ohm Speakers	51 – 58
Speaker Rough-In Mounting Rings	59 – 59
Audio Wall Plates, Speaker & Volume Controls	60 – 61
Audio/Video Distribution Accessories	62 – 62
Application Diagrams	63 – 72
Reference Section	73 – 75
Glossary of Terms	76 – 76
Linear Training	77 – 77
Technical Support	78 – 78
Manufacturing Facilities	79 – 79
Distribution Centers	80 – 80
Index	81 – 81

02 Pre-Wiring Guide

Structured Wiring with Industry-Standard Cabling

Today's installations requirements demand multi-room audio/video entertainment and networking of telephone, Ethernet, intercom, RF television signals, digital whole-house music, video surveillance, and more. The key to an efficient and successful audio/video/data installation is to pre-wire using a system.

A structured wiring system is comprised of a network enclosure containing electronic modules that attach to a mounting grid. Cables route signals entering into the installation to the modules in the enclosure. From the modules, cables exit the enclosure and route to multi-function wall plates in each room of the installation.

One of the advantages of a structured wiring system is the flexibility offered to the homeowner by providing multiple interface jacks in every room throughout the residence. Another advantage is the "home run" routing of cables. Each wall plate has its own individual cable set routed back to the network enclosure. This allows flexibility when changing or adding services, easy troubleshooting, and a very high-quality signal path.

Installing the cables in the walls before the construction is completed allows the easy wiring access to all points in the residence.

Cable Types and Usage

Another important feature of Linear's audio/video/data solution products is the easy assembly of an integrated home network utilizing. The cable types listed here are available from a wide variety of manufacturers, ensuring competitive prices, availability, and compatibility, now and in the future.

RG-6

RF sources like CATV, off-air NTSC, and off-air ATSC (HDTV) use RG-6 coax with standard foil shield and aluminum braid. For DBS satellite installations—from dish, to multi-switch, to receiver—use standard RG-6. It is perfect for most residential situations. In commercial or extreme noise environments (such as near a radio or television transmitter tower), use quad-shielded RG-6.

Cat-5, Cat-5e, and Cat-6

Category 5, Category 5e (100 MHz rated), or even better, Category 6 (200 MHz rated) is recommended for telecommunication, intercom, Ethernet, and data applications. Category 5 (or higher) wiring has four unshielded twisted pairs (UTP) for eight wires total. It's reliable because of its tight accurate twist of wire pairs and the balanced mode of transmission. This design results in a cable that resists interference from common sources in the home, such as vacuums, microwave ovens, and power tools.

The TIA/EIA-570-A standard specifies that the length of each Cat-5 cable run should not exceed 295 ft. This guideline should determine where the network enclosure is located. In most homes, this length restriction is not an issue.

Access Port Recommendations

Linear's Total Access Port™ wall plates provide an easy way to terminate the installation's cables at each interface jack location. For future expansion and addition of upgrades, it is always good practice to run extra cables. It is recommended that an extra data and coaxial cable is available at each wall plate location.

CABLE RUNS RECOMMENDED BY LOCATION			
	TYPICAL ROOM	MEDIA CENTER	HOME OFFICE
GOOD	1 CAT-5, 1 RG-6	1 CAT-5, 3 RG-6	1 CAT-5, 2 RG-6
BETTER	2 CAT-5, 1 RG-6	2 CAT-5, 3 RG-6	2 CAT-5, 2 RG-6
BEST	2 CAT-5, 2 RG-6	3 CAT-5, 3 RG-6	3 CAT-5, 3 RG-6

RG-6 COAX CABLE

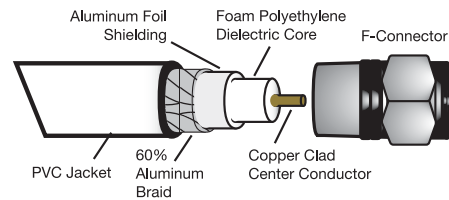

CAT-5 CONNECTION TO TAP WALL PLATE

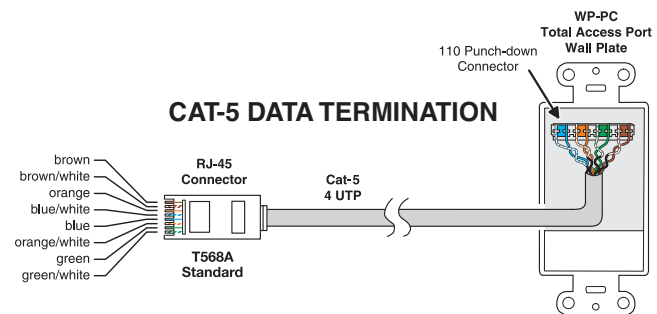
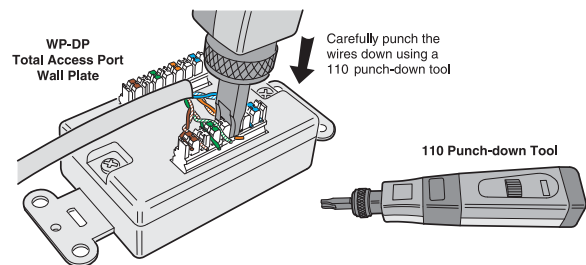

CAT-5 TELEPHONE PAIRS

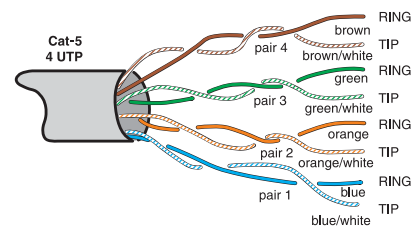

Pre-Wire for Direct Broadcast Satellite, Cable, and Off-Air High-Definition Digital Television with RG-6 Coax

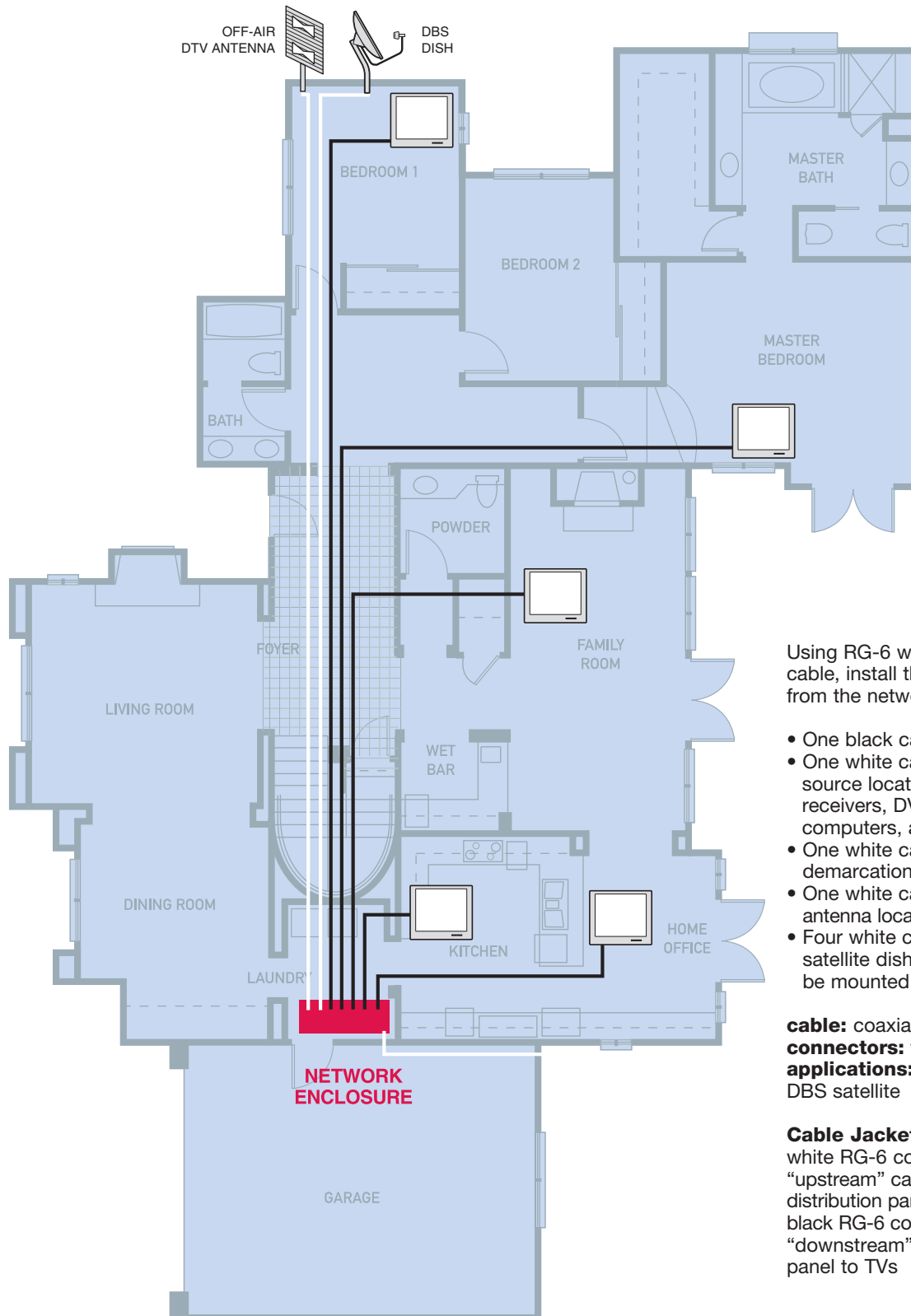

Using RG-6 white and black coaxial cable, install the following cable runs from the network enclosure:

- One black cable to each TV location.
- One white cable to each video source location (DVRs, DBS satellite receivers, DVD players, cameras, computers, and gaming boxes).
- One white cable to the CATV demarcation point.
- One white cable to an off-air DTV antenna location.
- Four white cables to a place where a satellite dish with a multi LNB might be mounted.

cable: coaxial cable type RG-6 75Ω

connectors: type F

applications: CATV, DTV antenna, and DBS satellite

Cable Jacket Color Coding

white RG-6 coax: use as a “send” or “upstream” cable from modulators to distribution panel

black RG-6 coax: use as “receive” or “downstream” cable from distribution panel to TVs

04 Pre-Wiring Guide

Pre-Wire Telephone, Intercom, and Digital Whole-House Audio, with Cat-5, Cat-5e, or Cat-6

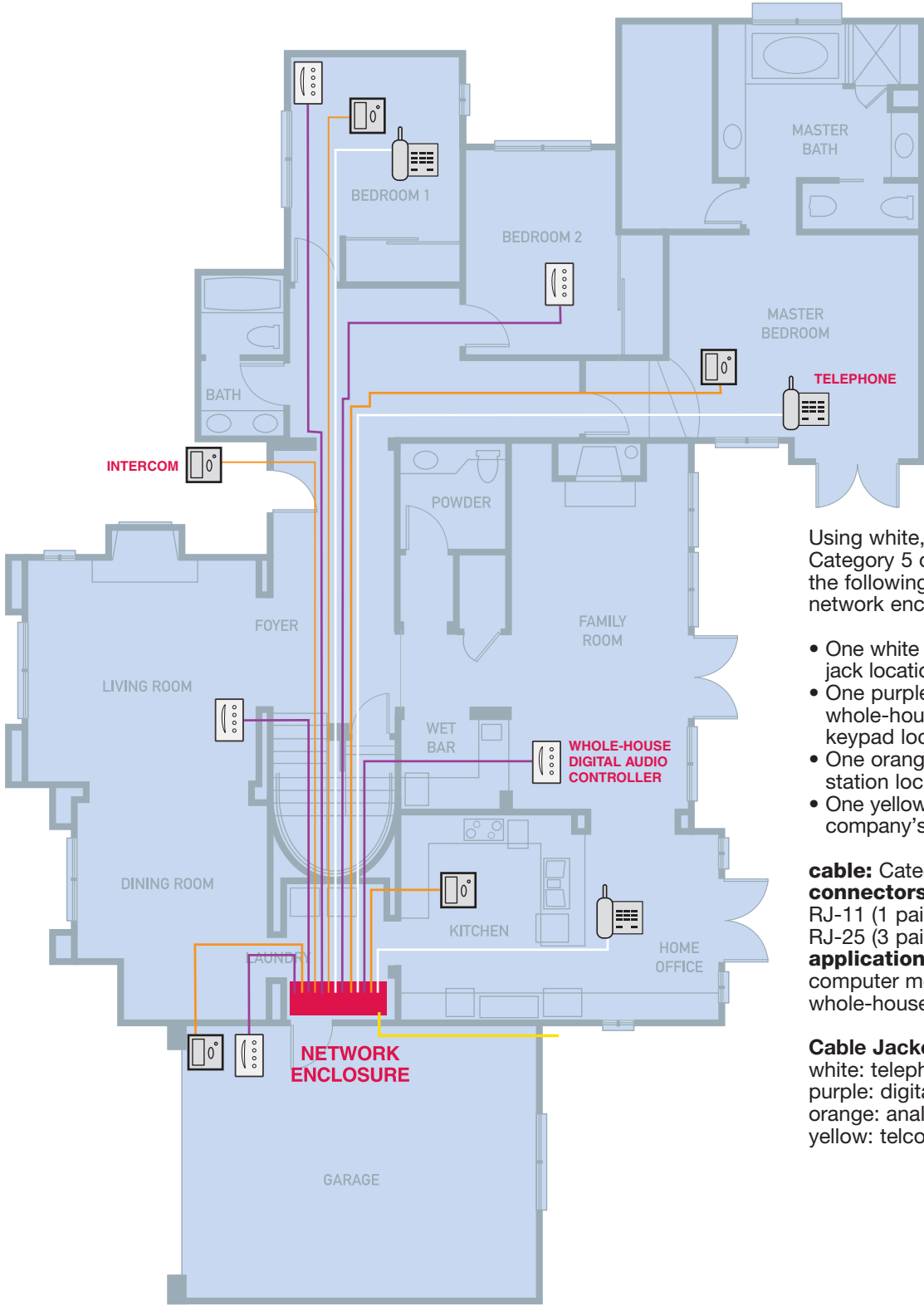

Using white, purple, yellow, or orange Category 5 or Category 6 cable, install the following cable runs from the network enclosure:

- One white cable to each telephone jack location.
- One purple cable to each whole-house digital audio controller keypad location.
- One orange cable to each intercom station location.
- One yellow cable to the telephone company's demarcation point.

cable: Category 5, 5e or Category 6

connectors: jacks and plugs type RJ-11 (1 pair), type RJ-14 (2 pair), type RJ-25 (3 pair), and RJ-45 (4 pair)

applications: telephone, fax, computer modem, intercom, whole-house audio

Cable Jacket Color Coding

- white: telephone
- purple: digital audio
- orange: analog audio
- yellow: telco line in

Pre-Wire Ethernet Data Network and Internet Access with Cat-5e or Cat-6

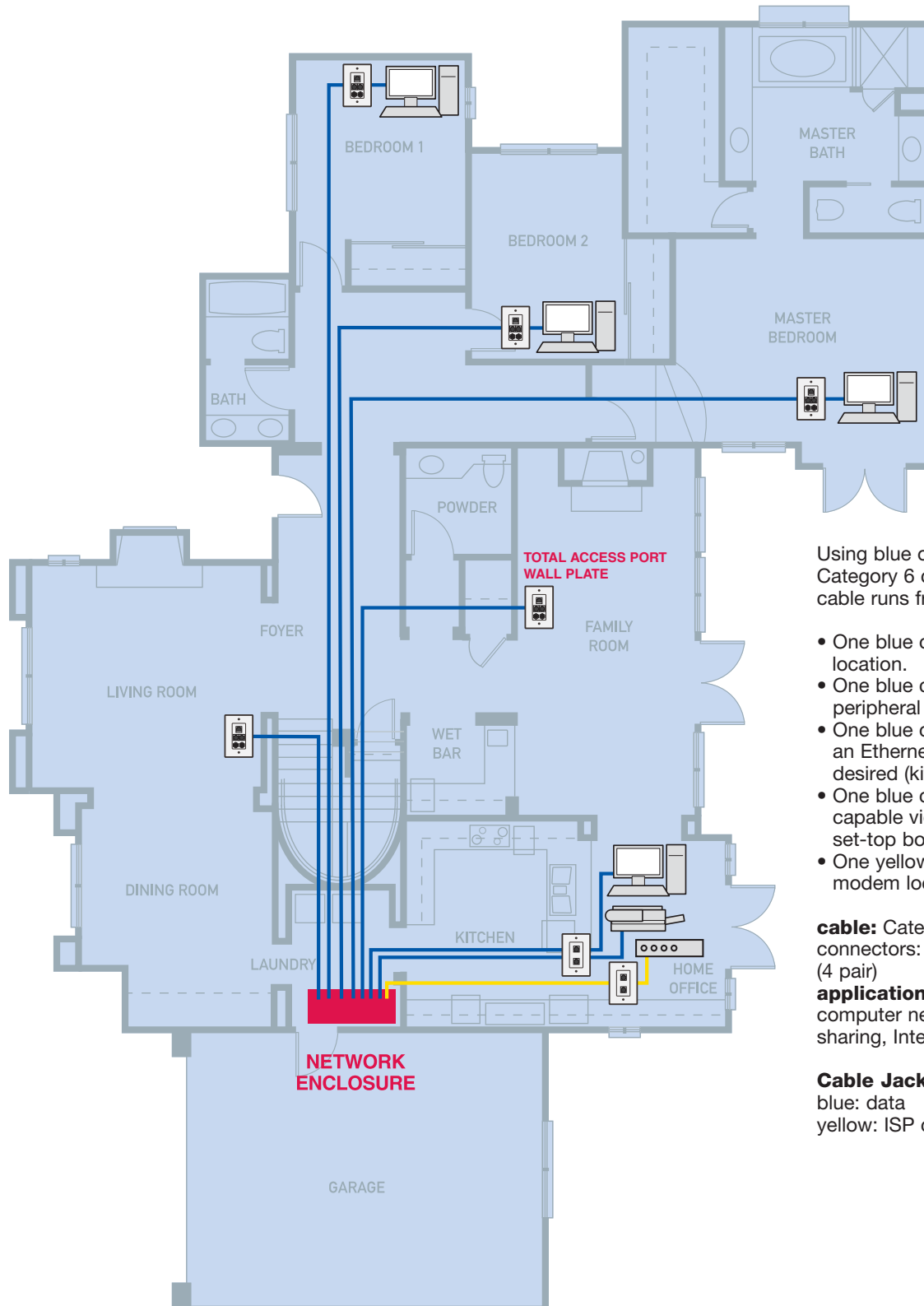

Using blue or yellow Category 5e or Category 6 cable, install the following cable runs from the network enclosure:

- One blue cable to each computer location.
- One blue cable to each computer peripheral location (such as a printer)
- One blue cable to any location where an Ethernet access wall plate is desired (kitchen, bedroom, or den).
- One blue cable to any Ethernet-capable video-on-demand DVR or set-top box.
- One yellow cable to DSL or cable modem location.

cable: Category 5e or Category 6 connectors: jacks and plugs type RJ-45 (4 pair)

applications: 100 BASE-T Ethernet for computer networking and printer sharing, Internet access from ISP.

Cable Jacket Color Coding

blue: data
yellow: ISP connection

06 High-Definition Video Distribution Components

HDMI-SW-2X2M

2x2 Switcher/Splitter for HDMI (Mirrored)

- ORDER # HDMI-SW-2X2M



SWITCH BETWEEN ANY TWO HDMI SOURCES AND OUTPUT TO TWO DISPLAYS. The Model HDMI-SW-2X2M 2x2 Switcher for HDMI (Mirrored) routes high-definition video in multiple resolutions up to 1080p plus multi-channel digital audio from either one of two sources to the two displays. Two outputs give you the option of sending high-definition audio and video signals to two displays simultaneously. A digital audio output port is available if you need to direct the audio to an A/V receiver. The 2x2 Switcher for HDMI eliminates the need to disconnect and reconnect sources to a display equipped with one input. It supports HDMI-compatible equipment such as HD cable and HD satellite set-top boxes, HD

DVRs, HD-DVD players, Blu-ray Disc players, and other sources with an HDMI output. By using the IR remote, either source is accessible at all times. Simply connect all your sources to the switcher's HDMI inputs. Then connect up to two displays on the switcher's HDMI outputs. Once the sources, the switcher, and the display(s) are powered and connected, you simply select which source you want to view using the IR remote. Includes 5-VDC power supply (regulatory approvals include UL and CE), RMT-2IR Remote Control, and two 6-ft. Mono-Lok HDMI cables.

Features:

- Switches easily between any two HDMI sources
- Outputs are mirrored to two HDMI displays simultaneously
- Additional digital optical audio output is extracted from the HDMI input for easy connection to multi-channel A/V receivers
- Extends the range of HDMI-compliant device by equalizing and reclocking the HDMI signal
- Supports resolutions up to 1080p, 2K, and 1920x1200
- HDMI/HDCP compliant

Specifications:

- Video amplifier bandwidth: 165 MHz
- Input video signal: 1.2 volts p-p
- Input DDC signal: 5 volts p-p (TTL)
- Single link range: 1080p/1920x1200
- HDMI connector: Type A 19-pin female
- Digital audio output: Optical
- Remote control port: RS232 female, external IR mini-stereo jack
- Power consumption: 20 watts (max)
- Dimensions: 10.25" W x 1.125" H x 4.25" D
- Shipping weight: 4 lbs.

HDMI-SW-2X4M

2x4 Switcher/Splitter for HDMI (Mirrored)

- ORDER # HDMI-SW-2X4M



SWITCH BETWEEN ANY TWO HDMI SOURCES AND OUTPUT TO FOUR DISPLAYS. The Model HDMI-SW-2X4M 2x4 Switcher/Splitter for HDMI (Mirrored) is equipped with two HDMI inputs and four HDMI outputs. Two inputs accommodate the simultaneous connection of up to two high-definition video sources. It supports HDMI-compatible equipment such as HD cable and HD satellite set-top boxes, HD DVRs, HD-DVD players, Blu-ray Disc players, and other sources with an HDMI output. Four outputs send the high-definition audio/video signals to up to four high-definition displays. Switching is done via the IR remote that is provided with the unit.

Simply connect all your sources to the switcher's HDMI inputs. Then connect up to four displays to the switcher's HDMI outputs. Once the sources, the switcher, and the display(s) are powered and connected, you simply select which source you want to view using the IR remote. Includes 5-VDC power supply (regulatory approvals include UL and CE), RMT-2IR Remote Control, and two 6-ft. Mono-Lok HDMI cables.

Features:

- Switches easily between any two HDMI sources
- Outputs are mirrored to four HDMI displays simultaneously
- Extends the range of HDMI-compliant device by equalizing and reclocking the HDMI signal
- Supports resolutions up to 1080p, 2K, and 1920x1200
- HDMI/HDCP compliant

Specifications:

- Video amplifier bandwidth: 165 MHz
- Input video signal: 1.2 volts p-p
- Input DDC Signal: 5 volts p-p (TTL)
- Single link range: 1080p/1920x1200
- HDMI connector: Type A 19-pin female
- Remote control port: RS232 female, mini-stereo
- Power consumption: 10 watts (max)
- Dimensions: 12 W" x 1.125" H x 4.25" D
- Shipping weight: 4 lbs.

High-Definition Video Distribution Components 07

HDMI-SW-3X1

3x1 Switcher for HDMI 1.3

- ORDER # HDMI-SW-3X1



CONNECT THREE HDMI-COMPLIANT DEVICES TO ONE DISPLAY. The Model HDMI-SW-3X1 3x1 Switcher for HDMI 1.3 allows you to enjoy the benefits of HDMI 1.3 while connecting multiple sources to one display. Linear's HDMI 3x1 switcher routes three high-definition video signals with multi-channel digital audio to one display with resolutions up to 1080p. Three inputs accommodate the simultaneous connection of up to three HDMI 1.3 high-definition video sources. It supports HDMI-compatible equipment such as HD cable and HD satellite set-top boxes, HD DVRs, HD-DVD players, Blu-ray Disc players, and other sources with an HDMI

output. The output sends the high-definition audio/video signals to a high-definition display. Switching is done via the IR remote that is provided with the unit.

Simply connect all your sources to the switcher's HDMI inputs. Then connect your display to the switcher's HDMI output. Once the sources, the switcher, and the display are powered and connected, you simply select which source you want to view using the IR remote or the select button on the front panel. Includes 5-VDC power supply (regulatory approvals include UL and CE), RMT-3 IR Remote Control, and three 6-ft. Mono-Lok HDMI cables.

Features:

- Switches easily between any three HDMI sources
- Discrete pushbutton for local switching
- Extends the range of HDMI-compliant devices by equalizing the HDMI signal
- Maintains high-resolution video beautifully, with sharp HDTV resolutions up to 1080p and 2K and computer resolutions up to 1920x1200
- HDMI 1.3/HDCP compliant

Specifications:

- Single link bandwidth: 225 MHz
- Input video signal: 1.2 volts p-p
- Input DDC signal: 5 volts p-p (TTL)
- Single link range: 1080p/1920x1200
- HDMI connector: Type A 19-pin female
- Remote control port: Mini-stereo jack
- Power consumption: 5 watts (max)
- Dimensions: 9.25" W x 1" H x 2.75" D
- Shipping weight: 4 lbs.

HDMI-SW-4X1

4x1 Switcher for HDMI 1.3

- ORDER # HDMI-SW-4X1



ROUTE FOUR HDMI SOURCES TO ONE DISPLAY. The Model HDMI-SW-4X1 4x1 Switcher for HDMI 1.3 routes high-definition video in multiple resolutions up to 1080p plus multi-channel digital audio from any of four sources to one display. Four HDMI inputs accommodate the simultaneous connection of up to four high-definition video sources. It supports HDMI-compatible equipment such as HD cable and HD satellite set-top boxes, HD DVRs, HD-DVD players, Blu-ray Disc players, and other sources with an HDMI output. The output sends the high-definition audio/video signals to a high-definition display. Switching is done via the IR remote that is provided with the unit.

Simply connect all your sources to the switcher's HDMI inputs. Then connect your display to the switcher's HDMI output. Once the sources, the switcher, and the display(s) are powered and connected, you simply select which source you want to view using the IR remote. Includes 5-VDC power supply (regulatory approvals include UL and CE), RMT-4IR Remote Control, and four 6-ft. Mono-Lok HDMI cables.

Features:

- Switches easily between any four HDMI sources
- Extends the range of HDMI-compliant devices by equalizing the HDMI signal
- Supports resolutions up to 1080p, 2K, and 1920x1200
- HDMI 1.3/HDCP compliant

Specifications:

- Video amplifier bandwidth: 340 MHz
- Input video signal: 1.2 volts p-p
- Input DDC signal: 5 volts p-p (TTL)
- Single link range: 1080p/1920x1200
- HDMI connector: Type A 19-pin female
- Remote control port: RS232 female, mini-stereo jack
- Power consumption: 10 watts (max)
- Dimensions: 13.25" W x 1" H x 2.75" D
- Shipping weight: 6 lbs.

08 High-Definition Video Distribution Components

HDMI-SW-4X2M

4x2 Switcher for HDMI (Mirrored)

- ORDER # HDMI-SW-4X2M



ACCESS UP TO FOUR SOURCES FROM ONE OR TWO DISPLAYS. The Model HDMI-SW-4X2M 4x2 Switcher for HDMI (Mirrored) routes high-definition video in multiple resolutions up to 1080p plus multi-channel digital audio from any of four sources. Four inputs accommodate the simultaneous connection of up to four high-definition video sources. It supports HDMI-compatible equipment such as HD cable and HD satellite set-top boxes, HD DVRs, HD-DVD players, Blu-ray Disc players, and other sources with an HDMI output. Two outputs send the high-definition audio/video signals to up to two high-definition displays. A digital audio output port is available if you need to direct the audio to

an audio receiver. Switching is done via the IR remote that is provided with the unit. You simply connect all your sources to the switcher's HDMI inputs. Then connect up to two displays on the switcher's HDMI outputs. Once the sources, the switcher, and the display(s) are powered and connected, you simply select which source you want to view using the IR remote. Includes 5-VDC power supply (regulatory approvals include UL and CE), RMT-4IR Remote Control, and four 6-ft. Mono-Lok HDMI cables.

Features:

- Switches easily between any four HDMI sources
- Outputs are mirrored to two HDMI displays simultaneously
- Additional digital coax audio output is extracted from the HDMI input for easy connection to a multi-channel audio receiver
- Extends the range of HDMI-compliant devices by equalizing and reclocking the HDMI signal
- Supports resolutions up to 1080p, 2K, and 1920x1200
- HDMI/HDCP compliant

Specifications:

- Video amplifier bandwidth: 165 MHz
- Input video signal: 1.2 volts p-p
- Input DDC signal: 5 volts p-p (TTL)
- Single link range: 1080p/1920x1200
- HDMI connector: Type A 19-pin female
- Digital audio output: SPDIF
- Remote control port: RS232 female, mini-stereo
- Power consumption: 20 watts (max)
- Dimensions: 11" W x 1.25" H x 4.25" D
- Shipping weight: 5 lbs.

COMP-DA-1X3 1:3 Component with Audio Distribution Amplifier

- ORDER # COMP-DA-1X3



DISTRIBUTE ONE COMPONENT SOURCE TO THREE DISPLAYS. The Model COMP-DA-1X3 1:3 Component with Audio Distribution Amplifier is the perfect solution for anyone who needs to send one source of high-definition component video and analog or digital audio to multiple displays at the same time. It supports component equipment, such as DVD players, satellite set-top boxes, and all component displays. In operation, the component video source is connected to the distribution amplifier at the input. Three outputs are available to be used in part or in full. Once the unit is connected and powered, the source is distributed to three component high-definition displays at the same time.

Simply connect the source's component and audio cables to the 1:3's input. Then connect up to three component displays to the 1:3's outputs. Power on the unit and watch high-definition up to 1080p on up to three displays without any signal loss or picture degradation. When two or more 1:3s are connected together, you can create a larger video distribution system. Includes 5-VDC power supply (regulatory approvals include UL and CE) and one 6-ft. component cable.

Features:

- Connects up to three component displays at the same time to one video source
- Supports HDTV (Component, YPbPr, RGsB) and SD (Composite, YCbCr) input signals
- Supports HDTV resolutions up to 1080p
- Both analog and digital audio outputs are active

Specifications:

- Input: YPbPr x1 or RGsB x1 (or RGBHV), or Composite x1 1V p-p @ 75 Ohm
- Output: YPbPr x3, or RGsB (or RGBHV) x3, or Composite x3
- Audio input: Digital (SPDIF) x1 + R/L x1
- Audio output: Digital (SPDIF) x3 + R/L x3
- Analog audio input/output: Audio 2V rms max 47k Ohm
- Bandwidth: 480 MHz (-3dB)
- Video range: 480i, 480p, 720p, 1080i, and 1080p
- Dimensions: 5.5" W x 1.5" H x 3.65" D
- Shipping weight: 3 lbs.

High-Definition Video Distribution Components

09

COMP-DA-1X8

1:8 Component with Audio Distribution Amplifier

- ORDER # COMP-DA-1X8



DISTRIBUTE ONE COMPONENT SOURCE TO EIGHT DISPLAYS. The Model COMP-DA-1X8 1:8 Component with Audio Distribution Amplifier is the perfect solution for anyone who needs to send one source of high-definition component video and analog or digital audio to multiple displays at the same time. It supports component equipment, such as DVD players, satellite set-top boxes, and component displays. In operation, the component video source is connected to the distribution amplifier at the input. Eight outputs are available to be used in part or in full. Once the unit is connected and powered, the source is distributed to eight component high-definition displays at the same time.

Simply connect the source's component and audio cables to the 1:8's input. Then connect up to eight component displays to the 1:8's outputs. Power on the unit and watch high-definition up to 1080p on up to eight displays without any signal loss or picture degradation. When two or more 1:8s are connected together, you can create a larger video distribution system. Includes 5-VDC power supply (regulatory approvals include UL and CE), one 6-ft. 5-RCA Component/R+L cable, and rack ears.

Features:

- Connects up to eight component displays at the same time to one video source
- Supports HDTV (Component, YPbPr, RGB) and SD (Composite, YCbCr) input signals
- Supports HDTV resolutions up to 1080p
- Both analog and digital audio outputs are active

Specifications:

- Input: YPbPr x1 or RGB x1 (or RGBHV), or Composite x1 1V p-p @ 75 Ohm
- Output: YPbPr x8, or RGB (or RGBHV) x8, or Composite x8
- Audio input: Digital (SPDIF) x1 + R/L x1
- Audio output: Digital (SPDIF) x8 + R/L x8
- Analog audio input/output: Audio 2V rms max 47k Ohm
- Bandwidth: 480 MHz (-3dB)
- Video range: 480i, 480p, 720p, 1080i, and 1080p
- Dimensions: 17.5" W x 1.75" H x 6.75" D
- Rack mountable: 1U rack space
- Shipping weight: 8 lbs.

HDMI-DA-1X8

1:8 Distribution Amplifier for HDMI

- ORDER # HDMI-DA-1X8



DISTRIBUTE ONE HDMI SOURCE TO UP TO EIGHT DISPLAYS. The Model HDMI-DA-1X8 1:8 Distribution Amplifier for HDMI is the perfect solution for anyone who needs to send one source of digital high-definition video to multiple displays at the same time. It supports HDMI-compatible equipment such as HD cable and HD satellite set-top boxes, HD DVRs, HD-DVD players, Blu-ray Disc players, and other sources with an HDMI output. In operation, the digital video source is connected to the distribution amplifier's one input while eight HDMI outputs are available to be used in part or in full. Once the unit is connected and powered, your source can be distributed to up to eight digital displays at the same time.

Simply connect your HDMI video source to the 1:8 Distribution Amplifier's input using the supplied HDMI cable. Then connect up to eight HDMI displays to the unit's eight HDMI outputs. Once connected and powered, your source can be seen on all eight displays at the same time. When two or more 1:8s are connected together, you can create a larger distribution system. Includes 24-VDC power supply (regulatory approvals include UL and CE), one 6-ft. HDMI cable, and rack ears.

Features:

- Connects up to eight HDMI/DVI* displays at the same time to one video source
- Output is mirrored to eight HDMI/DVI* displays simultaneously
- Supports resolutions up to 1080p, 2K, and 1920x1200
- Extends the range of HDMI-compliant devices by equalizing and reclocking the HDMI signal
- HDMI/HDCP compliant

*When used with an HDMI to DVI Adapter

Specifications:

- Video amplifier bandwidth: 165 MHz
- Input video signal: 1.2 volts p-p
- Input DDC signal: 5 volts p-p (TTL)
- Single link range: 1080p/1920x1200
- HDMI connector: Type A 19-pin female
- Power consumption: 60 watts (max)
- Dimensions: 17" W x 1.75" H x 5.5" D
- Rack mountable: 1U rack space
- Shipping weight: 6 lbs.

10 High-Definition Video Distribution Components

HDMI-DA-2X8M

2:8 Distribution Amplifier for HDMI (Mirrored)

- ORDER # HDMI-DA-2X8



DISTRIBUTE TWO HDMI SOURCES TO EIGHT HDMI DISPLAYS. The Model HDMI-DA-2X8M 2:8 Distribution Amplifier for HDMI (Mirrored) is the perfect solution for anyone who needs to send one or two sources of digital high-definition video to multiple displays at the same time. It supports HDMI-compatible equipment such as HD cable and HD satellite set-top boxes, HD DVRs, HD-DVD players, Blu-ray Disc players, and other sources with an HDMI output. In operation, the digital source is connected to the distribution amplifier's input while eight HDMI outputs are available to be used in part or in full. Once the unit is connected and powered, your source can be distributed to up to eight digital displays at the same time.

Simply connect your two HDMI video sources to the 2:8 HDMI Distribution Amplifier. Then connect up to eight HDMI displays to the unit's eight HDMI outputs. Once connected and powered, your source will be seen on all eight displays at the same time. When two or more 2:8s are connected together, you can create larger distribution systems. Includes 24-VDC power supply (regulatory approvals include UL and CE), one 6-ft. Mono-Lok HDMI cable, RMT-2IR Remote Control, and rack ears.

Features:

- Switches easily between any two HDMI/DVI* sources
- Outputs are mirrored to eight HDMI/DVI* displays simultaneously
- Supports resolutions up to 1080p, 2K, and 1920x1200
- Extends the range of HDMI-compliant devices by equalizing and reclocking the HDMI signal
- HDMI/HDCP compliant

*When used with an HDMI to DVI Adapter

Specifications:

- Video amplifier bandwidth: 165 MHz
- Input video signal: 1.2 volts p-p
- Input DDC signal: 5 volts p-p (TTL)
- Single link range: 1080p/1920x1200
- HDMI connector: Type A 19-pin female
- Remote control port: RJ11 jack for serial control interface, external IR mini-stereo jack
- Power consumption: 60 watts (max)
- Dimensions: 17" W x 1.75" H x 5.5" D
- Rack mountable: 1U rack space
- Shipping weight: 5 lbs.

HDMI-MX-4X4

4x4 Matrix for HDMI

- ORDER # HDMI-MX-4X4



VIEW ANY FOUR HDMI SOURCES ON ANY FOUR DISPLAYS. The Model HDMI-MX-4X4 4x4 Matrix for HDMI allows maximum versatility and flexibility for creating an integrated HD system. The 4x4 Matrix routes digital audio and high-definition digital video in resolutions up to 1080p from any of four HDMI sources to any combination of four displays through the matrix. It supports HDMI-compatible equipment such as HD cable and HD satellite set-top boxes, HD DVRs, HD-DVD players, Blu-ray Disc players, and other sources with an HDMI output. Each source is accessible for viewing on any combination of displays by selecting it with the supplied IR remote.

Simply connect the sources to the Matrix's HDMI inputs. Then connect four displays to the Matrix's outputs. Once the sources, the Matrix, and the displays are powered and connected, you use the IR remote to select which sources you want to view on which displays. Includes 24-VDC power supply (regulatory approvals include UL and CE), RMT-16IR Remote Control, four 6-ft. Mono-Lok HDMI cables, and rack ears.

Features:

- Switches easily between any four HDMI sources
- Distributes any of the four inputs to any combination of the four HDMI output displays
- Supports resolutions up to 1080p, 2K, and 1920x1200
- Extends the range of HDMI-compliant devices by equalizing and reclocking the HDMI signal
- HDMI/HDCP compliant

Specifications:

- Video amplifier bandwidth: 165 MHz
- Input video signal: 1.2 volts p-p
- Input DDC signal: 5 volts p-p (TTL)
- Single link range: 1080p/1920x1200
- HDMI connector: Type A 19-pin female
- Remote control port: RS232 female, external IR mini-stereo jack
- Power consumption: 60 watts (max)
- Dimensions: 17" W x 1.75" H x 5.875" D
- Rack mountable: 1U rack space
- Shipping weight: 7 lbs.

High-Definition Video Distribution Components 11

COMP-CAT5-EXT

Component with Audio Extender
(Sender and Receiver)

- ORDER # COMP-CAT5-EXT



EXTENDS COMPONENT VIDEO AND AUDIO UP TO 1,000 FEET (300 METERS) OVER A SINGLE CAT-5, CAT-5E, OR CAT-6 CABLE. The Model COMP-CAT5-EXT Component with Audio Extender (Sender and Receiver) extends your audio and video signals with Cat-5 cable. Place your source anywhere and extend the signal up to 1,000 feet away. The Component with Audio Extender will extend Analog Component as well as Analog Audio or Digital Audio (SPDIF or Optical). All audio and video signals are transmitted digitally over a single Cat-5, Cat-5e, or Cat-6 cable, and both the analog and digital audio outputs are active on the receiver side.

The Component with Audio Extender sender unit connects to any component video and audio source using the supplied component and RCA cables. The receiver unit connects to your HDTV component video display and audio input up to 1,000 feet away. Only one Cat-5, Cat-5e, or Cat-6 cable is used to connect the sender to receiver for perfect video extension up to 1080p. The sender and receiver are powered by individual 5-VDC power supplies. Includes two 5-VDC power supplies (regulatory approvals include UL and CE), one 6-ft. component cable, and one 2 RCA L+R audio cable.

Features:

- Supports HDTV resolutions up to 1080p
- Supports analog L+R audio and multi-channel digital audio (SPDIF or Optical)
- No loss of quality
- Plug-and-play installation
- Equalization for Cat-5 signal skews
- Only one Cat-5, Cat-5e, Cat-6 cable is required
- Both analog and digital audio outputs are active on the receiver side

Specifications:

- Video amplifier bandwidth: 350 MHz
- Input video signal: 1.2 volts p-p
- Input sync signal: 5 volts p-p (TTL)
- Horizontal frequency range: 15–70 KHz
- Vertical frequency range: 30–170 Hz
- Video in/out: 3 RCA component
- Audio in/out: 2 RCA audio, one SPDIF, one Optical
- Link connector: RJ-45 shielded
- Power consumption: 5 watts (max.)
- Dimensions: 3" W x 1" H x 3.75" D
- Shipping weight: 4 lbs.

COMP-2-HDMI-AD

Component with Audio to HDMI Adapter

- ORDER # COMP-2-HDMI-AD



CONVERT COMPONENT VIDEO WITH AUDIO TO HDMI FOR DIGITAL DISPLAYS. The Model COMP-2-HDMI-AD Component with Audio to HDMI Adapter is a unique device that allows older analog devices to be integrated seamlessly into the modern home theater. This adapter connects component video home theater devices to HDMI-compliant digital monitors. This adapter also takes analog L+R audio and encodes it onto the HDMI signal for the full DMI video and audio effect. With the Component with Audio to HDMI Adapter, Legacy home theater devices and computer systems can be easily connected to any HDMI display for the full digital video and audio experience.

Simply connect the supplied component cable to the input side of the Component with Audio to HDMI Adapter. Connect the supplied RCA audio cables to the audio inputs of the Component with Audio to HDMI Adapter. Connect the HDMI display or projector input to the HDMI output of the Component with Audio to HDMI Adapter. The adapter generates the compatible analog to digital conversion signals for video and audio as well as encoding the audio onto the HDMI to make the connection between the analog inputs and the digital output work. Includes 5-VDC power supply (regulatory approvals include UL and CE), one 6-ft. RCA L+R audio cable, and one 6-ft. component cable.

Features:

- Allows you to connect your HDTV YPbPr source to an HDMI input
- Encodes analog audio onto the video signal for HDMI video and audio
- Supports HDTV resolution up to 1080p
- HDMI compliant

Specifications:

- Digital video amplifier bandwidth: 165 MHz
- Video amplifier bandwidth: 350 MHz
- Input video signal: 1.2 volts p-p
- Input DDC signal: 5 volts p-p (TTL)
- HDMI connector: Type A 19-pin female
- Video in: 3 RCA component
- Audio connector: Analog RCA L+R
- Power consumption: 10 watts (max)
- Dimensions: 4" W x 1" H x 4" D
- Shipping weight: 3 lbs.

12 High-Definition Video Distribution Components

HDMI-SB

Super Booster for HDMI Cables

- ORDER # HDMI-SB



EXTEND HDMI UP TO 200 FEET.

The Model HDMI-SB Super Booster for HDMI Cables is an attractive alternative to the traditional sender/receiver solutions for HD extension. The Super Booster for HDMI enables your standard “off the shelf” certified HDMI cable to transmit HDTV video plus multi-channel digital audio in a single cable way beyond the limited HDMI specification of 15 feet.

Up to 200 feet can be easily traversed using your certified HDMI cable plus a Super Booster for HDMI. The Super Booster for HDMI corrects any digital degradation that occurs when HDMI is used to send digital audio/video signals beyond the HDMI specification of 15 feet.

This plug-and-play installation takes mere seconds. Simply connect the certified HDMI cable on one side of the Super Booster for HDMI and the display’s cable on the other side. The Super Booster for HDMI sits between the end of your certified HDMI cable and your display. You also have the option of connecting another certified HDMI cable to the Booster, daisy-chaining Boosters and cables for greater distances.

Features:

- Perfect digital high-definition video sent over long stretches of certified HDMI cables
- Locate an HDMI display up to 200 feet away from any HDTV source
- Supports resolutions up to 1080p, 2K, and 1920x1200
- HDMI/HDCP compliant

Specifications:

- Video amplifier bandwidth: 165 MHz
- Input video signal: 1.2 volts p-p
- Input DDC signal: 5 volts p-p (TTL)
- Single link range: 1080p/1920 x 1200
- HDMI connector: Type A 19-pin female
- Source requires 50mA output for maximum performance
- Dimensions: 1.625” W x 0.75” H x 1.75” D
- Shipping weight: 0.5 lb.

IR-EXTENDER

Remote IR Extender

- ORDER # IR-EXTENDER



RELOCATE THE IR ON LINEAR HD PRODUCTS.

Features:

- Adds relocation flexibility to compatible Linear equipment during installation
- Dark-colored, tiny IR Eye module hides easily among equipment and furniture
- IR Extender enables a longer range of control than without the Extender
- Soft and flexible black cable fits in narrow spaces unobtrusively
- Rubber mat under Extender head unit ensures a no-scratch installation
- CFL/Plasma proof

Specifications:

- Connector: 1/8-inch mini-phono plug
- Cable length: 6 ft.
- Dimensions: 2” x 1.4” x 0.8” device, 0.1” diameter cable
- Color: Black
- Shipping weight: 2.1 ounces including cable

High-Definition Video Distribution Components

13

SCALER-2-1080P

High-Definition A/V Scaler for HDMI

• ORDER # SCALER-2-1080P



SCALING AND SWITCHING SOLUTION FOR S-VIDEO, COMPOSITE, COMPONENT, AND HDMI SOURCES.

The Model SCALER-2-1080P High-definition A/V Scaler for HDMI allows you to upscale and switch your standard definition or high-definition component and HDMI sources to resolutions up to 1080p. Anything from set-top boxes and DVD players to the next generation of gaming consoles can be plugged into the Linear High-definition A/V Scaler for HDMI.

The Linear High-definition A/V Scaler for HDMI supports one component source with analog audio, one composite or S-Video source with analog audio, and two HDMI sources with digital audio. The analog audio from the analog sources is digitized and output to the HDMI connection as well as the digital audio outs. The HDMI inputs also have separate digital audio inputs, so you can use DVI sources and separate digital audio. The High-definition A/V Scaler for HDMI will embed the digital audio into the HDMI output as well as the digital audio outs.

Simply connect all your components and your display. Easy-to-use on-screen menus are accessible through the IR remote control. The IR remote control allows for effortless setup and image adjustment to accommodate different viewing modes and screen sizes to perfect your final picture. Includes 5-VDC power supply (regulatory approvals include UL and CE) and one 6-ft. Mono-Lok HDMI cable.

Features:

- Both digital and analog inputs are format converted and pixel re-scaled through the Home Theater Scaler Plus. It outputs a large range of formats and resolutions that will easily match the native resolution/format of your display to ensure highest picture quality.
- DVI/HDCP/HDMI-compliant input: Operates up to 165 MHz (up to UXGA @ 60 Hz)
- Supports digital HD output up to 1080p
- Integrated 8-bit triple-ADC/PLL
- Integrated DVI/HDCP/HDMI-compliant receiver
- Dual high-quality scaling engines
- Dual 3-D motion video adaptive de-interlacers with smooth low-angle edge
- Automatic 3:2 pull-down and 2:2 pull-down detection and recovery
- High-performance frame rate conversion engine
- The Proprietary Advanced Color Engine technology gives you brilliant and fresh color, intensified contrast and details, vivid skin tone, sharp edges, accurate and independent color control
- Option to select audio input from HDMI or Optical/SPDIF audio source
- 3-D noise reduction on analog inputs only
- Operates through on-screen menu control and remote control
- Aspect ratio control
- Digital audio delay to match audio/video timing
- Less than one frame delay for gaming devices

Specifications:

- Digital video amplifier bandwidth: 165 MHz
- Component video bandwidth: 350 MHz
- Input DDC signal: 5 volts p-p (TTL)
- Input video signal: 1.2 volts p-p
- Single link range: 1080p/1920x1200
- Analog video in connector 1: 3 RCA Component
- Analog video in connector 2: 1 RCA Composite
- Analog video in connector 3: 1 S-Video
- HDMI input connector: 2 Type A 19-pin female
- HDMI output connector: 1 Type A 19-pin female
- Digital audio in connector: 2 Optical TOSLINK and 2 Coaxial SPDIF
- Digital audio out connector: 1 Optical TOSLINK and 1 Coaxial SPDIF
- Analog audio in connector: 3:2 RCA R+L
- Power consumption: 20 watts (max)
- Dimensions: 6.875" W x 2.125" H x 6.875" D
- Shipping weight: 4 lbs.

14 Audio/Video Distribution Systems

SVC-10

S-Video Cat-5 Distribution System with 12-Volt IR

- ORDER # SVC-10



Suggested Uses:

- Distribute unconverted audio and video from a music management system over a single Cat-5 cable
- Provide video and audio access to a distant location such as a pool house with no ground looping problems or coax required
- Create a cost-effective single-zone audio distribution system with unlimited power and simplified wiring
- Loop several units together for whole-house distribution
- Deliver high-quality audio and video to box seats in a sports arena
- Access the home theater from a bedroom with full IR remote control

Features:

- S-Video & composite video inputs
- Coax digital, optical digital 5.1, and analog stereo audio inputs
- Auto termination loop-through
- IR emitter and RJ-45 Cat-5 outputs
- 19-Inch rack mountable (one space)
- Automatic optical to coax digital audio conversion
- Adjustable picture compensation for length of wire run
- 17" W x 1.75" H x 6.5" D

SVC-10R

S-Video Cat-5 Receiver with 12-Volt IR

- ORDER # SVC-10R



Features:

- Composite and S-Video outputs
- Coax digital and analog audio outputs
- 12-Volt IR target input
- RJ-45 Cat-5 input
- Compact size: 4.6" W x 1" H x 3.2" D

SVD-8

Distribution Panel with Differential Drive

- ORDER # SVD-8



Suggested Uses:

- The SVD-8 is perfect when you need to send a single source to multiple locations over a long distance (up to 2,000 ft.)
- Combine SVC-10 and SVD-8 to distribute multiple sources over long distances such as in schools, training facilities, sports bars, video stores, or light commercial applications

Features:

- Cat-5 input
- Eight Cat-5 outputs
- Three IR emitter outputs (two mini-jacks, one 2-position terminal block)
- Power and IR indicators
- Cable length adjustment control for each output
- Slide-in labeling system (pre-printed labels provided)

RF Distribution Amplifiers 15

DA-520A

Bi-Directional RF Amplifier

- ORDER # DA-520A



The Model DA-520A Bi-directional RF Amplifier provides 20 dB of gain in a CATV or antenna system. The Model DA-520A has bi-directional capabilities with a 5–40 MHz bandwidth return path. This allows compatibility with interactive CATV set-top boxes. A 12-VDC Model 999-017-01 Power Supply is included.

Features:

- 54 MHz to 1 GHz forward bandwidth
- 5 MHz to 40 MHz reverse bandwidth
- ± 1.5 dB gain flatness
- Maximum input level 30 dBmv
- 3.5" W x 1.2" H x 2.5" D

DA-500A

RF Amplifier

- ORDER # DA-500A



The Model DA-500A RF Amplifier with 18 dB of gain is ideal for residential cable systems or as an antenna pre-amplifier. The DA-500A offers a robust power supply and great EMI rejection. It includes grid mounting ears for the Model 2619 Rack-mount Grid. The DA-500A is fully compatible with HDTV television signals.

Features:

- 50 MHz to 1 GHz bandwidth
- 18 dB nominal gain
- ± 1.5 dB gain flatness
- Maximum input level 40 dBmv
- 6.3" W x 1.25" H x 4.5" D

DA-506BID

Bi-Directional RF Distribution Amplifier

- ORDER # DA-506BID



The Model DA-506BID Bi-directional RF Distribution Amplifier creates an ideal entry-level product for broadband distribution. Encased in an extruded aluminum shell, the Model DA-506BID meets the needs of small distribution systems that do not require IR control or modulator inputs. The Model DA-506BID has one

input for CATV or an off-air antenna and six outputs for televisions. Four outputs are for televisions up to 75 feet away and two outputs can be used up to 150 feet away. The DA-506BID has bi-directional capabilities with a 5–42 MHz bandwidth return path on the CATV/antenna input. This allows compatibility with interactive CATV set-top boxes. Grid mount ears are included for mounting in the Model 2619 Rack-mount Grid. The DA-506BID IS compatible with broadcast DTV television signals on the VHF and UHF bands. The DA-506BID is NOT compatible with digital or analog CATV signals above 806 MHz (CATV channels 127–140).

Features:

- 54 MHz to 806 MHz forward bandwidth
- 5 MHz to 42 MHz reverse bandwidth
- 1 dB nominal gain on "short" TV outputs
- 4 dB nominal gain on "long" TV outputs
- ± 1.5 dB gain flatness
- Maximum input level 20 dBmv
- 6.3" W x 1.25" H x 4.5" D

H816BID Bi-Directional Economical Whole-House Video Distribution Amplifier

- ORDER # H816BID



The Model H816BID Bi-directional Economical Whole-house Video Distribution Amplifier distributes CATV or antenna signals to up to six televisions. Two of the six outputs feature additional

signal gain for longer RG-6 coax cable runs. The Model H816BID is bi-directional to support 2-way cable systems. The H816BID IS compatible with broadcast DTV television signals on the VHF and UHF bands. The H816BID is NOT compatible with digital or analog CATV signals above 806 MHz (CATV channels 127–140).

Features:

- Distributes CATV or antenna to six TVs
- Four standard outputs with 1 dB gain (for RG-6 coax runs up to 75 feet)
- Two long outputs with 4 dB gain (for RG-6 coax runs up to 150 feet)
- Bi-directional with a 5–42 MHz return path for cable modems, interactive applications, and pay-per-view boxes
- Six enclosure grid spaces
- 6.25" W x 1.25" H x 2.75" D

16 RF Distribution Amplifiers

DA-550BID Bi-Directional RF Distribution Amplifier with 12-Volt IR

- ORDER # DA-550BID



The Model DA-550BID Bi-directional RF Distribution Amplifier with 12-volt IR is the heart of a multi-room distribution system with outputs to eight televisions with coax runs up to 150 feet. The Model DA-550BID has three inputs, one from CATV and two from Linear 5400, 5500, or SVM series modulators. The Model DA-550BID can handle an extremely wide range of input signals

from NTSC and digital TV. The Model DA-550BID offers a 5–42 MHz bandwidth return path for bi-directional communication for use with digital cable interactive set-top boxes. The Model DA-550BID can be powered locally with its included power supply or remotely from up to 75 feet away by using an in-wall power injector wall plate Model 2010 or any 5500 series or SVM series modulator. The Model DA-550BID offers optional IR control of connected video sources and whole-house IR integration with a built-in 12-volt IR engine. Adding a Model 2100A Wall Plate and a 12-volt IR target to the coax run of any room allows IR signals to be routed to either a Model 2010 Wall Plate, 5500 series, or SVM series modulator.

Features:

- 54 MHz to 1 GHz forward bandwidth
- 5 MHz to 42 MHz reverse bandwidth
- 3 dB nominal gain on TV outputs
- Maximum input level 20 dBmv
- Can be used in locations without electrical access and powered remotely with a Linear modulator or the Model 2010 Wall Plate
- 6.5" W x 1.25" H x 4.5" D

DA-550HHR High-Headroom RF Distribution Amplifier with 12-Volt IR

- ORDER # DA-550HHR



The Model DA-550HHR High-headroom RF Distribution Amplifier with 12-volt IR is the heart of a multi-room distribution system with outputs to eight televisions with coax runs up to 150 feet. The Model DA-550HHR has three inputs, one from an off-air antenna or CATV and two from

Linear 5400, 5500, or SVM series modulators. The DA-550HHR is used with antenna applications for off-air digital and NTSC signals. The Model DA-550HHR can be powered locally with its included power supply or remotely from up to 75 feet away by using an in-wall power injector wall plate Model 2010 or any 5500 series or SVM series modulator. The Model DA-550HHR offers optional IR control of connected video sources and whole-house IR integration with a built-in 12-volt IR engine. Adding a Model 2100A Wall Plate and a 12-volt IR target to the coax run of any room allows IR signals to be routed to either a Model 2010 Wall Plate, 5500 series, or SVM series modulator.

Features:

- 54 MHz to 1 GHz forward bandwidth
- 3 dB nominal gain on TV outputs
- Maximum input level 20 dBmv
- Can be used in locations without electrical access and powered remotely with a Linear modulator or the Model 2010 Wall Plate
- 6.5" W x 1.25" H x 4.5" D

DA-8200BID Bi-Directional RF Distribution Amplifier with 5-Volt IR

- ORDER # DA-8200BID



The Model DA-8200BID Bi-directional RF Distribution Amplifier with 5-volt IR is the heart of a multi-room distribution system with outputs to eight televisions with coax runs up to 150 feet. The Model DA-8200BID has three inputs, one from CATV and two from Linear 5400, 5500, or SVM series modulators. The Model DA-8200BID can handle an extremely wide range of input signals from NTSC and digital TV. The Model DA-8200BID offers a 5–42 MHz bandwidth

return path for bi-directional communication for use with digital cable interactive set-top boxes. The Model DA-8200BID can be powered locally with its included power supply or remotely from up to 75 feet away by using an in-wall power injector wall plate Model 2010 or any 5500 series or SVM series modulator. The Model DA-8200BID features optional IR control of connected video sources and whole-house IR integration with a built-in 5-volt IR engine. Model 2133 Set-top IR Targets connect between the amplifier outputs and the television sets. IR emitters connected to the amplifier, or to a 5500 or SVM series IR-enabled modulator connected to the amplifier, will repeat the IR remote control signals back to the video source component.

Features:

- 54 MHz to 1 GHz forward bandwidth
- 5 MHz to 42 MHz reverse bandwidth
- 3 dB nominal gain on TV outputs
- Maximum input level 20 dBmv
- Can be used in locations without electrical access and powered remotely with a Linear modulator or the Model 2010 Wall Plate
- 6.5" W x 1.25" H x 4.5" D

RF Distribution Amplifiers 17

DA-8200HHR High-Headroom RF Distribution Amplifier with 5-Volt IR

- ORDER # DA-8200HHR



The Model DA-8200HHR High-headroom RF Distribution Amplifier with 5-volt IR is the heart of a multi-room distribution system with outputs to eight televisions with coax runs up to 150 feet. The Model DA-8200HHR has three inputs, one from an off-air antenna or CATV and two from Linear 5400, 5500, or SVM series

modulators. The DA-8200HHR is used with antenna applications for off-air digital and NTSC signals.

The Model DA-8200HHR can be powered locally with its included power supply or remotely from up to 75 feet away by using an in-wall power injector wall plate Model 2010 or any 5500 series or SVM series modulator. The Model DA-8200HHR features optional IR control of connected video sources and whole-house IR integration with a built-in 5-volt IR engine. Model 2133 Set-top IR Targets connect between the amplifier outputs and the television sets. IR emitters connected to the amplifier, or to a 5500 or SVM series IR-enabled modulator connected to the amplifier, will repeat the IR remote control signals back to the video source component.

Features:

- 54 MHz to 1 GHz forward bandwidth
- 3 dB nominal gain on TV outputs
- Maximum input level 20 dBmV
- Can be used in locations without electrical access and powered remotely with a Linear modulator or the Model 2010 Wall Plate
- 6.5" W x 1.25" H x 4.5" D

H838BID Bi-Directional Video Hub with 5-Volt IR

- ORDER # H838BID

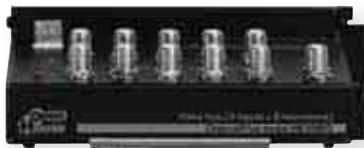

The Model H838BID Bi-directional Video Hub with 5-volt IR (for use with cable TV feeds) amplifies the incoming signal and provides

outputs to eight television locations in the home. In addition, each has two modulator inputs to add locally generated channels from DVD players, satellite receivers, VCRs, digital cable boxes, and front door, back door, and baby room cameras. Every TV location in the home receives every cable or antenna channel plus every modulator-generated video channel. In addition, the Model H838BID has a built-in IR engine that allows infrared remote control of the video equipment from any TV location. The Model H838BID has a return path for bi-directional CATV, perfect for use with cable modems and pay-per-view boxes.

Features:

- Distributes CATV to eight TVs
- Two modulator inputs to add locally generated channels (camera or DVD)
- Bi-directional with a 5-42 MHz return path for cable modems, interactive applications, and pay-per-view boxes
- IR repeating system using 5-volt targets
- Five enclosure grid spaces
- 6.25" W x 3.25" H x 2.25" D

H838HHR High-Headroom Video Hub with 5-Volt IR

- ORDER # H838HHR



The Model H838HHR High-headroom Video Hub with 5-volt IR (for use with off-air antennas) amplifies the incoming signal and provides outputs to eight television locations in the home. In addition, it has two modulator inputs to add locally generated channels from

DVD players, satellite receivers, VCRs, digital cable boxes, and front door, back door, and baby room cameras. Every TV location in the home receives every cable or antenna channel plus every modulator-generated video channel. In addition the Model H838HHR has a built-in IR engine that allows infrared remote control of the video equipment from any TV location. The Model H838HHR has a high-headroom amplifier that handles signal differences between high-powered analog VHF and low-powered digital UHF stations. The Model H838HHR is used with antennas for off-air digital and analog TV signals.

Features:

- Distributes CATV to eight TVs
- Two modulator inputs to add locally generated channels (camera or DVD)
- High-headroom amplifier
- IR repeating system using 5-volt targets
- Antenna isolation compliant with FCC part 15 requirements
- Five enclosure grid spaces
- 6.25" W x 3.25" H x 2.25" D

18 Audio/Video Modulators

3015

2-Input Video Distribution System

- ORDER # 3015



The Model 3015 2-input Video Distribution System accepts a CATV or antenna input and audio/video signals from one video source and modulates them to a user-selected channel that can be seen at four TV locations.

The modulator channel is digitally programmed. Push the channel select button to choose the desired unused TV channel and the internal microprocessor digitally sets the modulator to the exact FCC channel specification. The channel setting is retained in memory during a power failure.

Features:

- All-in-one video distribution system
- Built-in modulator
- Modulator channel digitally programmed
- Programming retained in memory during power failures
- 5.5" W x 6.8" H x 2" D

3025 3-Input Video Distribution System with 5-Volt IR

- ORDER # 3025



The Model 3025 3-input Video Distribution System with 5-volt IR accepts a CATV or antenna input and audio/video signals from two video sources and modulates them to two user-selected channels that can be seen at five TV locations.

The modulator channels are digitally programmed. Push a channel select button to choose the desired unused TV channel and the internal microprocessor digitally sets the modulator to the exact FCC channel specification. The channel settings are retained in memory during a power failure.

The Model 3025 features optional IR control of connected video sources and whole-house IR integration with a built-in 5-volt IR engine. Model 2133 Set-top IR Targets connect between the amplifier outputs and the television sets. IR emitters connected to the amplifier will repeat the IR remote control signals back to the video source component.

Features:

- All-in-one video distribution system
- Built-in modulators
- Modulator channels digitally programmed
- Programming retained in memory during power failures
- 5.5" W x 6.8" H x 2" D

Audio/Video Modulators 19

5415

1-Channel Video Modulator

- ORDER # 5415



The Model 5415 1-channel Video Modulator has the same output power as the rest of the 5400 series, but it is a quarter of the size.

Video and stereo audio inputs are modulated to a programmable TV channel (stereo audio is converted to monaural audio after modulation). The Model 5415 Modulator offers video loop-through. A jumper on the Model 5415 terminates the video input at 75 ohms. When the jumper is removed, the input can be looped using a "Y" adapter to feed the video to a local monitor or VCR.

Features:

- One modulated TV channel
- Creates a TV channel for a camera or other video source
- Channel range: CATV 65–125 (excluding 95–99) and UHF 14–64
- Pushbutton digital programming of modulated channel
- Compatible with DA-8200 and DA-550 series distribution amplifiers
- 4.6" W x 1" H x 3.2" D

5425

2-Channel Video Modulator

- ORDER # 5425



The Model 5425 2-channel Video Modulator converts two video and stereo audio inputs to two programmable TV channels (stereo audio is converted to monaural audio after modulation). The Model 5425 Modulator offers video loop-through. Jumpers on the Model 5425 terminate the video inputs at 75 ohms. When a jumper is removed, the input can be looped using a "Y" adapter to feed the video to a local monitor or VCR.

Features:

- Two modulated TV channels
- Creates TV channels for cameras or other video sources
- Channel range: CATV 65–125 (excluding 95–99) and UHF 14–64
- Pushbutton digital programming of modulated channels
- Compatible with DA-8200 and DA-550 series distribution amplifiers
- 7.9" W x 1.5" H x 5.5" D

5435

3-Channel Video Modulator

- ORDER # 5435



The Model 5435 3-channel Video Modulator converts three video and stereo audio inputs to three programmable TV channels (stereo audio is converted to monaural audio after modulation). The Model 5435 Modulator offers video loop-through. Jumpers located on the back of the Model 5435 terminate the video inputs at 75 ohms. When a jumper is removed, the input can be looped using a "Y" adapter to feed the video to a local monitor or VCR.

Features:

- Three modulated TV channels
- Creates TV channels for cameras or other video sources
- Channel range: CATV 65–125 (excluding 95–99) and UHF 14–64
- Pushbutton digital programming of modulated channels
- Compatible with DA-8200 and DA-550 series distribution amplifiers
- 7.9" W x 1.5" H x 5.5" D

5445

4-Channel Video Modulator

- ORDER # 5445



The Model 5445 4-channel Video Modulator converts four video and stereo audio inputs to four programmable TV channels (stereo audio is converted to monaural audio after modulation). The Model 5445 Modulator offers video loop-through. Jumpers on the Model 5445 terminate the video inputs at 75 ohms. When a jumper is removed, the input can be looped using a "Y" adapter to feed the video to a local monitor or VCR.

Features:

- Four modulated TV channels
- Creates TV channels for cameras or other video sources
- Channel range: CATV 65–125 (excluding 95–99) and UHF 14–64
- Pushbutton digital programming of modulated channels
- Compatible with DA-8200 and DA-550 series distribution amplifiers
- 7.9" W x 1.5" H x 5.5" D

20 Audio/Video Modulators

5515

1-Channel Video Modulator with IR

- ORDER # 5515



The Model 5515 1-channel Video Modulator with IR has the same output power as the rest of the 5500 series, but it is a quarter of the size. Video and stereo audio inputs are modulated to a

programmable TV channel (stereo audio is converted to monaural audio after modulation). The Model 5515 has an IR emitter output jack and the ability to remotely power a DA-550 or DA-8200 series distribution amplifier from up to 75 feet away. The Model 5515 works with both the 12-volt and 5-volt IR systems and accessories. The Model 5515 Modulator offers video loop-through. A jumper on the Model 5515 terminates the video input at 75 ohms. When the jumper is removed, the input can be looped using a "Y" adapter to feed the video to a local monitor or VCR.

Features:

- One modulated TV channel
- Creates a TV channel for a camera or other video source
- Channel range: CATV 65–125 (excluding 95–99) and UHF 14–64
- IR remote control signals from an IR target pass back through the system coax to an IR emitter
- Pushbutton digital programming of modulated channel
- Can remotely power DA-8200 and DA-550 series distribution amplifiers
- 4.6" W x 1" H x 3.2" D

5525

2-Channel Video Modulator with IR

- ORDER # 5525



The Model 5525 2-channel Video Modulator with IR converts two video and stereo audio inputs to two programmable TV channels (stereo audio is converted to monaural audio after

modulation). The Model 5525 has IR emitter output jacks and the ability to remotely power a DA-8200 or DA-550 series distribution amplifier from up to 75 feet away. The Model 5525 works with both the 12-volt and 5-volt IR systems and accessories. The Model 5525 Modulator offers video loop-through. Jumpers on the Model 5525 terminate the video inputs at 75 ohms. When a jumper is removed, the input can be looped using a "Y" adapter to feed the video to a local monitor or VCR.

Features:

- Two modulated TV channels
- Creates TV channels for cameras or other video sources
- Channel range: CATV 65–125 (excluding 95–99) and UHF 14–64
- IR remote control signals from IR targets pass back through the system coax to IR emitters
- Pushbutton digital programming of modulated channels
- Can remotely power DA-8200 and DA-550 series distribution amplifiers
- 7.9" W x 1.5" H x 5.5" D

5545

4-Channel Video Modulator with IR

- ORDER # 5545



The Model 5545 4-channel Video Modulator with IR converts four video and stereo audio inputs to four programmable TV channels (stereo audio is converted to monaural audio after modulation). The Model 5545 has IR emitter output jacks and the ability to remotely power a DA-8200 or DA-550 series distribution amplifier from up to 75 feet away. The Model 5545 works with both the 12-volt and 5-volt IR systems and accessories. The Model 5545 Modulator offers video loop-through. Jumpers on the Model 5545 terminate the video inputs at 75 ohms. When a jumper is removed, the input can be looped using a "Y" adapter to feed the video to a local monitor or VCR.

Features:

- Four modulated TV channels
- Creates TV channels for cameras or other video sources
- Channel range: CATV 65–125 (excluding 95–99) and UHF 14–64
- IR remote control signals from IR targets pass back through the system coax to IR emitters
- Pushbutton digital programming of modulated channels
- Can remotely power DA-8200 and DA-550 series distribution amplifiers
- 7.9" W x 1.5" H x 5.5" D

Audio/Video Modulators 21

5555BID Bi-Directional RF Distribution Kit with 12-Volt IR System

• ORDER # 5555BID



The Model 5555BID Bi-directional RF Distribution Kit with 12-volt IR System offers many of the basic components needed to assemble an 8-room TV distribution system. The kit includes the following:

- (1) - Model DA-550BID Bi-directional RF Distribution Amplifier with 12-volt IR
- (1) - Model 5545 4-channel Modulator with IR
- (3) - Model 2100A In-wall Interfaces
- (2) - Model 2172 Dual-head IR Emitters
- (5) - Model 2501-10 DC Blocking Capacitors

The kit provides eight rooms of amplified bi-directional cable TV distribution from the Model DA-550BID Amplifier; four injected TV channels from the Model 5545 Modulator; IR control of four audio/video source components with the two Model 2172 Dual-head IR Emitters; three rooms of wall plate termination with IR target and emitter jacks with the Model 2100A In-wall IR Interfaces (Model 2130A or Model 2132 Set-top IR Targets not included); and five rooms without IR control using the Model 2501-10 Blocking Capacitors.

Features:

- Four modulated TV channels create TV channels for cameras or other video sources
- IR remote control signals from IR targets pass back through the system coax to IR emitters
- In-wall interfaces fit Decora®-style wall plates for a professional looking installation
- Easily expandable with additional Linear components

5555HHR High-Headroom RF Distribution Kit with 12-Volt IR System

• ORDER # 5555HHR



The Model 5555HHR High-headroom RF Distribution Kit with 12-volt IR System offers many of the basic components needed to assemble an 8-room TV distribution system. The kit includes the following:

- (1) - Model DA-550HHR High-headroom RF Distribution Amplifier with 12-volt IR
- (1) - Model 5545 4-channel Modulator with IR
- (3) - Model 2100A In-wall Interfaces
- (2) - Model 2172 Dual-head IR Emitters
- (5) - Model 2501-10 DC Blocking Capacitors

The kit provides eight rooms of amplified off-air antenna or 1-way cable TV distribution from the Model DA-550HHR Amplifier; four injected TV channels from the Model 5545 Modulator; IR control of four audio/video source components with the two Model 2172 Dual-head IR Emitters; three rooms of wall plate termination with IR target and emitter jacks with the Model 2100A In-wall IR Interfaces (Model 2130A or Model 2132 Set-top IR Targets not included); and five rooms without IR control using the Model 2501-10 Blocking Capacitors.

Features:

- Four modulated TV channels create TV channels for cameras or other video sources
- IR remote control signals from IR targets pass back through the system coax to IR emitters
- In-wall interfaces fit Decora®-style wall plates for a professional looking installation
- Easily expandable with additional Linear components

22 Audio/Video Modulators

5557BID Bi-Directional RF Distribution Kit with 5-Volt IR System

• ORDER # 5557BID



The Model 5557BID Bi-directional RF Distribution Kit with 5-volt IR System offers many of the basic components needed to assemble an 8-room TV distribution system. The kit includes the following:

- (1) - Model DA-8200BID Bi-directional RF Distribution Amplifier with 5-volt IR
- (1) - Model 5525 2-channel Modulator with IR
- (2) - Model 2133 Set-top IR Targets
- (1) - Model 2172 Dual-head IR Emitter

The kit provides eight rooms of amplified bi-directional cable TV distribution from the Model DA-8200BID Amplifier; two injected TV channels from the Model 5525 Modulator; IR control of two audio/video source components with the Model 2172 Dual-head IR Emitter; and two rooms of IR remote control using the Model 2133 Set-top IR Targets.

Features:

- Two modulated TV channels create TV channels for cameras or other video sources
- IR remote control signals from IR targets pass back through the system coax to IR emitters
- Easily expandable with additional Linear components

5557HHR High-Headroom RF Distribution Kit with 5-Volt IR System

• ORDER # 5557HHR



The Model 5557HHR High-headroom RF Distribution Kit with 5-volt IR System offers many of the basic components needed to assemble an 8-room TV distribution system. The kit includes the following:

- (1) - Model DA-8200HHR High-headroom RF Distribution Amplifier with 5-volt IR
- (1) - Model 5525 2-channel Modulator with IR
- (2) - Model 2133 Set-top IR Targets
- (1) - Model 2172 Dual-head IR Emitter

The kit provides eight rooms of amplified off-air antenna or 1-way cable TV distribution from the Model DA-8200HHR Amplifier; two injected TV channels from the Model 5525 Modulator; IR control of two audio/video source components with the Model 2172 Dual-head IR Emitter; and two rooms of IR remote control using the Model 2133 Set-top IR Targets.

Features:

- Two modulated TV channels create TV channels for cameras or other video sources
- IR remote control signals from IR targets pass back through the system coax to IR emitters
- Easily expandable with additional Linear components

Audio/Video Modulators 23

5558BID Bi-Directional RF Distribution Kit with 5-Volt IR System

• ORDER # 5558BID



The Model 5558BID Bi-directional RF Distribution Kit with 5-volt IR System offers many of the basic components needed to assemble an 8-room TV distribution system. The kit includes the following:

- (1) - Model DA-8200BID Bi-directional RF Distribution Amplifier with 5-volt IR
- (1) - Model 5545 4-channel Modulator with IR
- (3) - Model 2133 Set-top IR Targets
- (2) - Model 2172 Dual-head IR Emitters

The kit provides eight rooms of amplified bi-directional cable TV distribution from the Model DA-8200BID Amplifier; four injected TV channels from the Model 5545 Modulator; IR control of four audio/video source components with the two Model 2172 Dual-head IR Emitters; and three rooms of IR remote control using the Model 2133 Set-top IR Targets.

Features:

- Four modulated TV channels create TV channels for cameras or other video sources
- IR remote control signals from IR targets pass back through the system coax to IR emitters
- Easily expandable with additional Linear components

5558HHR High-Headroom RF Distribution Kit with 5-Volt IR System

• ORDER # 5558HHR



The Model 5558HHR High-headroom RF Distribution Kit with 5-volt IR System offers many of the basic components needed to assemble an 8-room TV distribution system. The kit includes the following:

- (1) - Model DA-8200HHR High-headroom RF Distribution Amplifier with 5-volt IR
- (1) - Model 5545 4-channel Modulator with IR
- (3) - Model 2133 Set-top IR Targets
- (2) - Model 2172 Dual-head IR Emitters

The kit provides eight rooms of amplified off-air antenna or 1-way cable TV distribution from the Model DA-8200HHR Amplifier; four injected TV channels from the Model 5545 Modulator, IR control of four audio/video source components with the two Model 2172 Dual-head IR Emitters; and three rooms of IR remote control using the Model 2133 Set-top IR Targets.

Features:

- Four modulated TV channels create TV channels for cameras or other video sources
- IR remote control signals from IR targets pass back through the system coax to IR emitters
- Easily expandable with additional Linear components

24 Audio/Video Modulators

SVM-22

2-Input S-Video Modulator

• ORDER # SVM-22



The Model SVM-22 2-input S-Video Modulator offers complete MTS stereo encoding and S-Video inputs in a full component-size rack-mountable case. The Model SVM-22 is a 2-channel stereo modulator with 25 dBmV of output and easy pushbutton programming. The unit incorporates S-Video inputs that support both S-Video and composite video feeds with included adapters. Offering full MTS stereo with dbx® noise reduction and compatibility with Dolby Pro Logic® makes the Model SVM-22 perfect for integration into any home theater system.

The Model SVM-22 offers integrated IR control. Each modulator has an IR emitter output jack and is compatible with both 12-volt and 5-volt IR systems. The Model SVM-22 can remotely power DA series amplifiers from up to 75 feet away.

The Model SVM-22 offers full loop-through outputs with 75-ohm auto-termination. By connecting video/audio cables to the output jacks, all video and audio signals will pass through for use with a local monitor, VCR, or DVR.

The Model SVM-22 is designed to fit any 19" EIA rack (mounting ears included). The unit is one rack space high.

Features:

- S-Video inputs
- Full MTS stereo sound
- dbx® noise reduction
- Supports Dolby Pro Logic®
- Surround-sound support
- Can remotely power DA series amplifiers
- Mounts with other home theater components in a 19" EIA rack
- Integrated IR control—compatible with 5-volt and 12-volt systems

SVM-24

4-Input S-Video Modulator

• ORDER # SVM-24



The Model SVM-24 4-input S-Video Modulator offers complete MTS stereo encoding and S-Video inputs in a full component-size rack-mountable case. The Model SVM-24 is a 4-channel stereo modulator with 25 dBmV of output and easy pushbutton programming. The unit incorporates S-Video inputs that support both S-Video and composite video feeds with included adapters. Offering full MTS stereo with dbx® noise reduction and compatibility with Dolby Pro Logic® makes the Model SVM-24 perfect for integration into any home theater system.

The Model SVM-24 offers integrated IR control. Each modulator has an IR emitter output jack and is compatible with both 12-volt and 5-volt IR systems. The Model SVM-24 can remotely power a DA series amplifier from up to 75 feet away.

The Model SVM-24 offers full loop-through outputs with 75-ohm auto-termination. By connecting video/audio cables to the output jacks, all video and audio signals will pass through for use with a local monitor, VCR, or DVR.

The Model SVM-24 is designed to fit any 19" EIA rack (mounting ears included). The unit is one rack space high.

Features:

- S-Video inputs
- Full MTS stereo sound
- dbx® noise reduction
- Supports Dolby Pro Logic®
- Surround-sound support
- Can remotely power DA series amplifiers
- Mounts with other home theater components in a 19" EIA rack
- Integrated IR control—compatible with 5-volt and 12-volt systems

Data, Telephone & Video Distribution Modules 25

DMD-16

Data Distribution Module

- ORDER # DMD-16



The Model DMD-16 Data Distribution Module provides a superior way to terminate data connections. Each unit has 16 un-bridged 110 punch-down termination points that are aligned with a corresponding RJ-45 connector. Rated for Cat-5e performance in data networks, the Model DMD-16 is an excellent data termination hub for use with an Ethernet hub for LAN networks.

The Model DMD-16 can also be used as a termination point for control signals over Cat-5, video and audio signals, home control signals, security camera video, and KSU and PBX phone systems.

Features:

- Cat-5e certified
- Un-bridged termination hub
- 16 data locations
- Labeling system

DMT-16

Telephone Distribution Module with Surge Protection

- ORDER # DMT-16

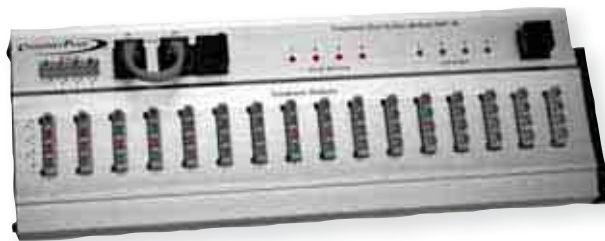

The Model DMT-16 Telephone Distribution Module with Surge Protection will accept four incoming telephone lines and distribute them to 16 locations with 110 punch-down connectors. It is made of brushed aluminum and can be easily mounted into the Linear rack-mounted grid system (Model 2619). Each unit comes with integrated surge suppression, a master disconnect, and an RJ-31X connection for alarm systems. Additional features include individual line LED indicators for surge events and an easy labeling system for integrated wire management and location identification.

Features:

- Four phone lines
- 16 locations (110 punch-down connectors)
- 4-Line surge protection
- RJ-31X security interface
- Test and expansion jacks
- Integrated labeling system
- Stand-off design for built-in wire management

DMT-24

Telephone Distribution Module with Surge Protection

- ORDER # DMT-24



The Model DMT-24 Telephone Distribution Module with Surge Protection will accept four incoming telephone lines and distribute them to 24 locations with RJ-45 outputs. It is made of brushed aluminum and can be easily mounted into the Linear rack-mounted grid system (Model 2619). Each unit comes with integrated surge suppression, a master disconnect, and an RJ-31X connection for alarm systems. Additional features include individual line LED indicators for surge events and an easy labeling system for integrated wire management and location identification.

Features:

- Four phone lines
- 24 locations (RJ-45 connectors)
- 4-Line surge protection
- RJ-31X security interface
- Test and expansion jacks
- Integrated labeling system
- Stand-off design for built-in wire management

26 Data, Telephone & Video Distribution Modules

H628

Data Termination Hub

- ORDER # H628



The Model H628 Data Termination Hub terminates up to eight Cat-5 data lines. The hub features eight RJ-45 jacks and eight 110 punch-down connectors. Each RJ-45 jack connects directly to its associated 110 punch-down connector.

Features:

- Certified 100 Base-T performance
- Cat-5e performance in a multi-port hub
- Terminates eight Cat-5e cables
- 110 punch-down connectors
- Circuits may be bridged

H629

Data/Telecom Termination Hub

- ORDER # H629



The Model H629 Data/Telecom Termination Hub provides a superior way to terminate data connections. The unit includes eight Cat-5 bridgeable circuits (110 punch-down connectors to RJ-45 jacks) and terminates eight Cat-5 wires. The Model H629 also offers eight additional 110 punch-down connectors for bridging up to four telephone lines. The unit is the ideal wiring interface for the Linear Model H650 Integrated Voice Network.

Features:

- Certified 100 Base-T performance
- Eight Cat-5e bridgeable circuits (110 to RJ-45)
- Cat-5e performance in a multi-port hub
- Terminates eight Cat-5 cables
- Additional 110 punch-down connectors for bridging telephone lines
- Ideal for interface with the H650

H611 Telephone Master Hub with Surge Protection

- ORDER # H611



The Model H611 Telephone Master Hub with Surge Protection provides a superior method of telephone connection for structured wiring systems. The Model H611 interfaces up to four incoming telephone lines with a home security system, provides surge protection for each individual line, and features a master disconnect jumper. The module can be expanded through either the RJ-45 or 110 punch-down connectors.

Features:

- Telephone service for four lines
- Surge protection with LED indicator
- RJ-31X for seizure of line one
- System test port-line disconnect
- Output expansion on RJ-45 or 110 punch-down connector
- Six enclosure grid spaces
- 6.25" W x 1.25" H x 2.75" D

H616

Telephone Master Hub

- ORDER # H616



The Model H616 Telephone Master Hub provides a superior method of telephone distribution for structured wiring systems. The Model H616 distributes up to four telephone lines to up to six telephone wall plates. An RJ-31X jack is provided for security system connection. Additionally, the Model H616 includes an RJ-45 jack for telephone line expansion.

Features:

- Telephone service for four lines with outputs to six separate locations
- RJ-31X for seizure of line one
- 110 punch-down connectors
- RJ-45 expansion jack
- Six enclosure grid spaces
- 6.25" W x 1" H x 2.75" D

Data, Telephone & Video Distribution Modules

27

H618

Telephone Expansion Hub

- ORDER # H618

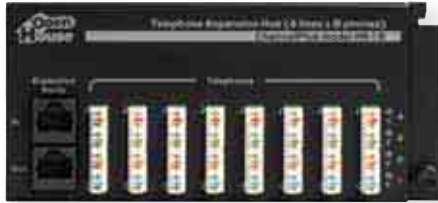

The Model H618 Telephone Expansion Hub distributes up to four telephone lines to up to eight telephone wall plates. The Model H618 also includes an RJ-45 expansion jack for connecting multiple H618s.

Features:

- Telephone service for four lines with outputs to eight locations
- Expansion accessory to models H611, H612, or H616
- 110 punch-down connectors
- Cat-5 jumper cable included
- Expansion jack for multiple H618s
- Six enclosure grid spaces
- 6.25" W x 1" H x 2.75" D

H619

RJ-45 Telephone Interface Hub

- ORDER # H619



The Model H619 Telephone Interface Hub distributes up to four telephone lines to up to 12 telephone locations via RJ-45 jacks. The Model H619 also includes RJ-45 expansion jacks for connecting multiple H619s.

Features:

- Telephone service for four lines with outputs to 12 separate locations
- 12 RJ-45 connectors for output
- Expandable to additional H619s
- Six enclosure grid spaces
- 6.25" W x 1" H x 2.75" D

H801

Combination Telephone/TV Hub

- ORDER # H801



Features:

- Telephone service for two lines to six locations
- 110 punch-down connectors
- Can be mounted upside down
- Distributes CATV/antenna to four TVs
- Six enclosure grid spaces
- 6.25" W x 1" H x 2.75" D

H802

Combination Telephone/TV Hub

- ORDER # H802



Features:

- Telephone service for four lines to six locations
- 110 punch-down connectors
- Can be mounted upside down
- Distributes CATV/antenna to four TVs
- Six enclosure grid spaces
- 6.25" W x 1" H x 2.75" D

28 Data, Telephone & Video Distribution Modules

H803

Splitter/Combiner Hub

- ORDER # H803



Features:

- 3-Way balanced designed
- 6.5 dB insertion loss @ 1,000 MHz
- 5–1,000 MHz bandwidth covers FM, cable modem, VHF and UHF bands
- -130 dB RFI rejection
- PCB design for consistent performance
- Tilted 15° for easy connections
- Return loss (IN and OUT) 20 dB minimum (all frequencies)
- Isolation (OUT to OUT) 22–25 dB (all frequencies)
- Six enclosure grid spaces
- 6.25" W x 1" H x 2.75" D

H804

Splitter/Combiner Hub

- ORDER # H804



Features:

- 4-Way balanced design
- 7.8 dB insertion loss @ 1,000 MHz
- 5–1,000 MHz bandwidth covers FM, cable modem, VHF and UHF bands
- -130 dB RFI rejection
- PCB design for consistent performance
- Tilted 15° for easy connections
- Return loss (IN and OUT) 20 dB minimum (all frequencies)
- Isolation (OUT to OUT) 22–25 dB (all frequencies)
- Six enclosure grid spaces
- 6.25" W x 1" H x 2.75" D

H806

Splitter TV Hub

- ORDER # H806



Features:

- 6-Way splitter
- 5–1,000 MHz bandwidth covers FM, cable modem, VHF and UHF bands
- -130 dB RFI rejection
- Less than 12 dB insertion loss
- Greater than 16 dB return loss
- Five enclosure grid spaces
- 6.25" W x 2.25" H x 2.25" D

H808

Splitter TV Hub

- ORDER # H808



Features:

- 8-Way splitter
- 5–1,000 MHz bandwidth covers FM, cable modem, VHF and UHF bands
- -130 dB RFI rejection
- Less than 13 dB insertion loss
- Greater than 16 dB return loss
- Five enclosure grid spaces
- 6.25" W x 2.25" H x 2.25" D

Structured Wire Intercom Components 29

DMC-10KIT

Structured Wire Intercom Kit

- ORDER # DMC-10KIT



The Model DMC-10KIT Structured Wire Intercom Kit is an intercom system designed for structured wire installation in residential or light commercial applications. The kit includes the following:

- (1) - DMC-10H Structured Wire Intercom Hub
- (4) - DMC-10RS Intercom Room Stations
- (1) - DMC-10DS Intercom Door Station
- (1) - 12-volt Switching Power Supply

The room, door, and patio stations showcase a new, contemporary design, crafted to blend smoothly into the installation's decor. Station faceplates are available in a variety of colors to further customize each installation. Room station keypads are illuminated with soft blue indicators while the intercom is in use. The door and patio station keys are illuminated with white lighting for easy nighttime operation.

The heart of the system is the Model DMC-10H Structured Wire Intercom Hub. The system hub grid mounts in a structured wiring enclosure (not included, Linear H312KIT recommended). Up to eight room, door, and patio stations in any combination can be connected to the system hub using up to 500 feet of standard Cat-5 cable for each station. For larger installations, a second system hub can be added for expansion, providing a total system capacity of up to 16 stations. The Model DMC-10AWP Audio Input Wall Plate can be added to the system to connect an external audio source for distribution throughout the intercom system.

Each room and patio station supports several useful features. Privacy mute disables the station's microphone to prevent monitoring from other stations. The do-not-disturb feature disables the station's microphone and speaker to prevent monitoring and interruption. Hands-free reply lets the person called respond without having to press any room station keys.

The room, patio, and door stations mount inside standard 2-gang junction boxes and are easy to install and wire. Each station and the system hub contain color-coded Type 110 punch-down terminal blocks for fast and reliable connection to Cat-5 cable. A 12-volt switching power supply is included with each intercom hub. For access control, the optional Model DRW Door Release Mechanism can be installed and activated from room stations. A choice of three door chime sounds is available for each door station connected. For interior stations, use the Model DMC-10RS Room Stations. For exterior stations, use the Model DMC-10PS Patio Stations and the Model DMC-10DS Door Stations.

Features:

- Supports any mix of up to eight room, patio, or door stations, up to 16 stations using two hubs
- Hub connects to stations with standard Cat-5 wiring (up to 500 feet per station)
- Type 110 punch-down Cat-5 color-coded terminals for stations and optional expansion hub
- Privacy mute and door release overrides selectable by station
- 3-Amp-rated integral door release relay
- Operational status indicators on hub for each station
- Hub grid mounts in structured wiring enclosure (not included, Linear H312KIT recommended)
- Contemporary design room stations with multi-level blue keypad backlighting
- White faceplate included on room stations; almond and black available to match any decor
- White faceplate included on door station; bright brass, antique brass, and satin nickel available to match any decor
- Room station door talk, door release, mute functions, do-not-disturb, hands-free communications, and audible 8-step digital volume control
- Extended-life white LED backlit doorbell button on door station for easy night operation
- Choose from three distinct chime sounds for door station
- Door, room, and patio stations fit standard 2-gang J-box

30 Structured Wire Intercom Components

DMC-10H

Structured Wire Intercom Hub

- ORDER # DMC-10H

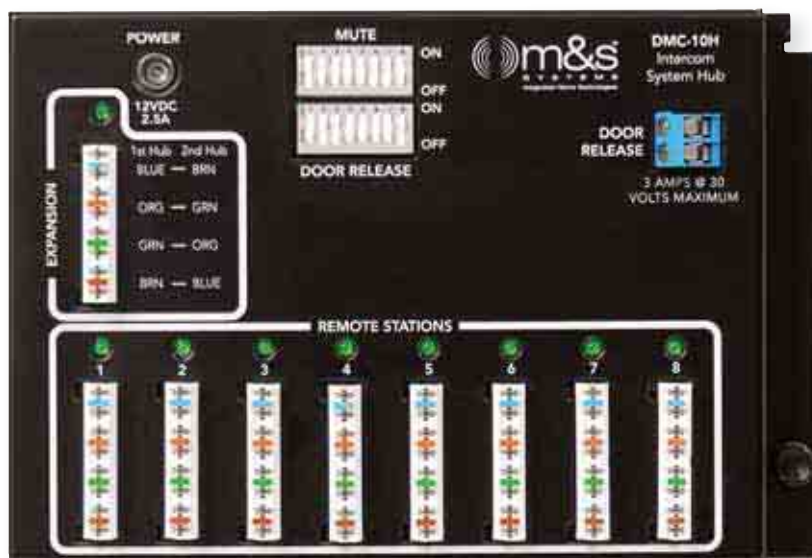

The Model DMC-10H Structured Wire Intercom Hub is an intercom system hub designed for structured wire installation in residential or light commercial applications. The system hub grid mounts in a structured wiring enclosure (not included, Linear H312KIT recommended). Up to eight room, door, and patio stations in any combination can be connected to the system hub using up to 500 feet of standard Cat-5 cable for each station. For larger installations, a second system hub can be added for expansion, providing a total system capacity of up to 16 stations. The Model DMC-10AWP Audio Input Wall Plate can be added to the system to connect an external audio source for distribution throughout the intercom system.

Each room and patio station supports several useful features. Privacy mute disables the station's microphone to prevent monitoring from other stations. The do-not-disturb feature disables the station's microphone and speaker to prevent monitoring and interruption. Hands-free reply lets the person called respond without having to press any room station keys. The room, patio, and door stations mount inside standard 2-gang junction boxes and are easy to install and wire. Each station and the system hub contain color-coded Type 110 punch-down terminal blocks for fast and reliable connection to Cat-5 cable. A 12-volt switching power supply is included with each intercom hub. For access control, the optional Model DRW Door Release Mechanism can be installed and activated from room stations. A choice of three door chime sounds is available for each door station connected.

For interior stations, use the Model DMC-10RS Room Stations. For exterior stations, use the Model DMC-10PS Patio Stations and the Model DMC-10DS Door Stations.

Features:

- Supports any mix of up to eight room, patio, or door stations, up to 16 stations using two hubs
- Hub connects to stations with standard Cat-5 wiring (up to 500 feet per station)
- Type 110 punch-down Cat-5 color-coded terminals for stations and optional expansion hub
- Privacy mute and door release overrides selectable by station
- 3-Amp-rated integral door release relay
- Operational status indicators on hub for each station
- Hub grid mounts in structured wiring enclosure (not included, Linear H312KIT recommended)
- Room station door talk, door release, mute functions, do-not-disturb, hands-free communications, and audible 8-step digital volume control
- Choose from three distinct chime sounds for door station
- Door and room stations fit standard 2-gang J-box

Structured Wire Intercom Components

31

DMC-10RS

Intercom Room Station

- ORDER # DMC-10RS



Features:

- Contemporary design with multi-level blue keypad backlighting
- White faceplate included; almond and black available to match any decor
- Door talk and door release
- Privacy mute feature
- Do-not-disturb feature
- Hands-free reply
- Audible 8-step digital volume control
- Fits in standard 2-gang J-box

DMC-10DS

Intercom Door Station

- ORDER # DMC-10DS



Features:

- Choose from three distinct chime sounds for door station
- Contemporary design with multi-level white keypad backlighting
- White faceplate included; antique brass, bright brass, and satin nickel available to match any decor
- Fits in standard 2-gang J-box

DMC-10AWP

Audio Input Wall Plate

- ORDER # DMC-10AWP



Features:

- External audio input connection for DMC-10H Structured Wire Intercom Hub
- Mounts in a single-gang J-box
- Fits Decora® faceplate
- One pair of color-coded RCA jacks
- One dry contact mute output mini-jack
- LED audio signal indicator
- Adjustable audio level control

DMC-10PS

Intercom Patio Station

- ORDER # DMC-10PS



Features:

- Choose from three distinct chime sounds for door station
- Contemporary design with multi-level white keypad backlighting
- White faceplate included; antique brass, bright brass, and satin nickel available to match any decor
- Fits in standard 2-gang J-box

32 Structured Wire Intercom Components

DMC-10DFAB-4

Door Station Faceplates (4-pack) (Antique Brass)

- ORDER # DMC-10DFAB-4



DMC-10PFAB-4

Patio Station Faceplates (4-pack) (Antique Brass)

- ORDER # DMC-10PFAB-4



DMC-10RFA-4

Room Station Faceplates (4-pack) (Almond)

- ORDER # DMC-10RFA-4



DMC-10DFBB-4

Door Station Faceplates (4-pack) (Bright Brass)

- ORDER # DMC-10DFBB-4



DMC-10PFBB-4

Patio Station Faceplates (4-pack) (Bright Brass)

- ORDER # DMC-10PFBB-4

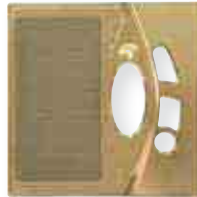

DMC-10RFB-4

Room Station Faceplates (4-pack) (Black)

- ORDER # DMC-10RFB-4



DMC-10DFSN-4

Door Station Faceplates (4-pack) (Satin Nickel)

- ORDER # DMC-10DFSN-4



DMC-10PFSN-4

Patio Station Faceplates (4-pack) (Satin Nickel)

- ORDER # DMC-10PFSN-4



DMC-10RFW-4

Room Station Faceplates (4-pack) (White)

- ORDER # DMC-10RFW-4



DMC-10DFW-4

Door Station Faceplates (4-pack) (White)

- ORDER # DMC-10DFW-4



DMC-10PFW-4

Patio Station Faceplates (4-pack) (White)

- ORDER # DMC-10PFW-4



RF Splitters, Filters & Accessories 33

2509-10

9 dB Tap (10-pack)

- ORDER # 2509-10



Features:

- 10-Piece bulk pack
- 1 GHz bandwidth
- 1 dB straight through loss
- 9 dB loss at tap
- Use as signal tap or combiner

2512 DC & IR Passing 2-Way Splitter/Combiner

- ORDER # 2512
- ORDER # 2512-25 (25-PACK)

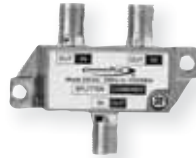

Features:

- 1 GHz bandwidth
- 3.5 dB insertion loss
- Passes DC IR signals on the coax
- Use as signal splitter or combiner

2514 DC & IR Passing 4-Way Splitter/Combiner

- ORDER # 2514
- ORDER # 2514-25 (25-PACK)



Features:

- 1 GHz bandwidth
- 8 dB insertion loss
- Passes DC IR signals on the coax
- Use as signal splitter or combiner

2532

2-Way Splitter/Combiner

- ORDER # 2532
- ORDER # 2532-25 (25-PACK)



Features:

- 1 GHz bandwidth
- 4 dB insertion loss
- Use as signal splitter or combiner

2534

4-Way Splitter/Combiner

- ORDER # 2534
- ORDER # 2534-25 (25-PACK)



Features:

- 1 GHz bandwidth
- 9 dB insertion loss
- Use as signal splitter or combiner

2538

8-Way Splitter/Combiner

- ORDER # 2538



Features:

- 1 GHz bandwidth
- 12 dB insertion loss
- Use as signal splitter or combiner

NF-469 Notch Filter

- ORDER # NF-469



Features:

- Notch filter frequency 469.25 MHz to 497.25 MHz
- Rejects CATV channels 64 to 70
- Allows insertion of CATV channels 65, 66, 67, 68, and 69
- Rejects off-air UHF TV channels 14 to 19
- Allows insertion of UHF TV channels 15, 16, 17, and 18
- 3.25" L x 1" W

NF-470 Notch Filter

- ORDER # NF-470



Features:

- Notch filter frequency 499.25 MHz to 523.25 MHz
- Rejects CATV channels 70 to 74
- Allows insertion of CATV channels 71, 72, and 73
- Rejects off-air UHF TV channels 19 to 23
- Allows insertion of UHF TV channels 20, 21, and 22
- 3.25" L x 1" W

NF-471 Notch Filter

- ORDER # NF-471



Features:

- Notch filter frequency 529.25 MHz to 559.25 MHz
- Rejects CATV channels 75 to 80
- Allows insertion of CATV channels 76, 77, 78, and 79
- Rejects off-air UHF TV channels 24 to 29
- Allows insertion of UHF TV channels 25, 26, 27, and 28
- 3.25" L x 1" W

34 RF Splitters, Filters & Accessories

LPF-380

Low-Pass Filter

- ORDER # LPF-380



Features:

- 0 to 380 MHz band-pass frequency
- Passes off-air TV channels 2 to 13
- Passes CATV channels 2 to 50
- Allows insertion of TV channels 14 to 69
- Allows insertion of CATV channels 55 to 125

LPF-470

Low-Pass Filter

- ORDER # LPF-470



Features:

- 0 to 470 MHz band-pass frequency
- Passes off-air TV channels 2 to 13
- Passes CATV channels 2 to 64
- Allows insertion of TV channels 18 to 69
- Allows insertion of CATV channels 69 to 125

LPF-600

Low-Pass Filter

- ORDER # LPF-600



Features:

- 0 to 600 MHz band-pass frequency
- Passes off-air TV channels 2 to 35
- Passes CATV channels 2 to 86
- Allows insertion of TV channels 40 to 69
- Allows insertion of CATV channels 91 to 125

LPF-750

Low-Pass Filter

- ORDER # LPF-750



Features:

- 0 to 750 MHz band-pass frequency
- Passes off-air TV channels 2 to 60
- Passes CATV channels 2 to 116
- Allows insertion of TV channels 65 to 69
- Allows insertion of CATV channels 121 to 125

2501-10 Blocking Capacitor (10-pack)

- ORDER # 2501-10



Features:

- 10-Piece bulk pack
- Blocks DC IR signals
- Passes RF signals
- Type "F" barrel connector

2503-10 3 dB In-Line Attenuator (10-pack)

- ORDER # 2503-10



Features:

- 10-Piece bulk pack
- Reduces signal strength 3 dB
- Type "F" barrel connector

RF Splitters, Filters & Accessories

35

2506-10 6 dB In-Line Attenuator (10-pack)

- ORDER # 2506-10



Features:

- 10-Piece bulk pack
- Reduces signal strength 6 dB
- Type "F" barrel connector

2507-10 75-Ohm Terminator (10-pack)

- ORDER # 2507-10



Features:

- 10-Piece bulk pack
- Terminates unused splitter outputs with a balanced 75-ohm load
- Type "F" male connector

TC-200A Tilt Compensator

- ORDER # TC-200A



Features:

- Compensates for high-frequency signal loss on long coax runs
- Female "F" and male "F" connectors
- Includes Female-Female barrel connector for in-line use

C-BCK Cable Box Combiner Kit

- ORDER # C-BCK



Allows a CATV Box to be tuned to all normal CATV channels, with modulated channels on custom channel numbers.

Features:

- Two 2-way splitter/combiners
- High-pass filter
- Two 6-inch coax cables with type "F" connectors

V902 Satellite Signal Diplexer

- ORDER # V902



Features:

- 40 MHz to 2150 MHz bandwidth
- Combines antenna and satellite dish signals together on one coax cable
- Splits antenna and satellite dish signals apart from one coax cable
- Female "F" ANT/SAT connector
- Female "F" ANT connector
- Female "F" SAT connector

36 Infrared Remote Controls

2010 In-Wall Power Injector IR Interface

- ORDER # 2010



Features:

- In-wall interface
- RF output
- Two IR emitter ports
- Power jack for remote power of DA-8200 and DA-550
- Decora®-style wall plate
- 1.3" W x 4" H x 2.2" D

2100A 12-Volt In-Wall IR Interface

- ORDER # 2100A



Features:

- In-wall interface
- RF output
- One IR target port
- One IR emitter port
- 12-Volt IR systems only
- Decora®-style wall plate
- 1.3" W x 4" H x 2.2" D

2130A 12-Volt Mini IR Target with Talk Back LED

- ORDER # 2130A



Features:

- 7-Foot cord with mini-stereo plug
- Red "talk back" LED tests system for correct wiring as well as indicates infrared reception
- Double-sided adhesive mounting
- Nominal reception range: > 30 feet
- Nominal reception angle: 55 degrees off axis

2131 12-Volt In-Wall Target with Talk Back LED

- ORDER # 2131



Features:

- 3-Wire connection to Model 2100A interface
- Red "talk back" LED tests system for correct wiring as well as indicates infrared reception
- J-box mounting
- Fits Decora®-style wall plates
- Includes dark lens for decorator-style wall plate
- Nominal reception angle: 45 degrees off axis
- Nominal reception range: > 25 feet
- Maximum cable length: One mile with 18 gauge
- 1.3" W x 4" H x 2.2" D

2132 12-Volt Set-Top Target with Talk Back LED

- ORDER # 2132



Features:

- 7-Foot cord with mini-stereo plug
- Red "talk back" LED tests system for correct wiring as well as indicates infrared reception
- Nominal reception range: > 30 feet
- Nominal reception angle: 45 degrees off axis
- 3.3" W x 1" H x 2" D

2133 5-Volt Set-Top Target

- ORDER # 2133



Features:

- Set-top target
- 5-Volt IR
- Use with 3025 and DA-8200 series distribution amplifiers
- Dual "F" connectors
- 3.3" W x 1" H x 2" D

Infrared Remote Controls

37

2171

Single-Head IR Emitter

- ORDER # 2171



Features:

- Compatible with 5-volt and 12-volt IR systems
- 5-Foot cord with mini-plug
- Use with video hubs, in-wall interfaces, and 5500 series modulators
- 0.3" W x 0.5" H x 0.3" D

2172

Dual-Head IR Emitter

- ORDER # 2172



Features:

- Compatible with 5-volt and 12-volt IR systems
- 5-Foot cord with mini-plug
- Use with video hubs, in-wall interfaces, and 5500 series modulators
- 0.3" W x 0.5" H x 0.3" D

2181

IR Coupler

- ORDER # 2181



Features:

- Allows IR control over multiple DA-550s or DA-8200s
- Compact in-line design
- Use one Model 2181 for each additional DA-550 or DA-8200
- 2.3" W x 1" H x 0.7" D

2184

IR Breakout Block

- ORDER # 2184



Features:

- Connects directly to DA-550 or DA-8200 distribution amplifiers
- Allows for local IR in enclosure
- Four emitter jacks
- One power jack
- One 4-position expansion terminal block
- 1.3" W x 3" H x 0.8" D

38 Structured Wiring Enclosures

H312KIT

12" Plastic Enclosure, Includes Cover

- ORDER # H312KIT



The Model H312KIT 12" Plastic Enclosure, Includes Cover provides grid mounting space for Linear structured wiring components. The enclosure is ETL Listed and features 19 grid inches of mounting capacity in two 9.5" columns. Structured wiring modules snap securely into the enclosure's mounting grid. Recommended enclosure for the DMC-10H Structured Wire Intercom Hub.

The enclosure mounts in the wall between standard 16-inch spaced studs, or it can be surface mounted. The flexi-mount system features four flexible mounting tabs on the sides of the enclosure. The flexi-mount tabs compensate for varying stud spacing and allow for adjusting the depth of the cabinet for flush mounting with all thicknesses of drywall.

A snap-on cover that can be screwed shut is supplied with the enclosure. The vented cover has a raised interior, allowing for easy wiring and better component cooling. Eight combination conduit knockouts (four along the top, two on the bottom, and one on each side) that fit either 2" or 0.5" conduit fittings are provided. The enclosure has an additional knockout on the bottom to mount a single-gang junction box for AC outlet installation.

Features:

- 12 inches high
- 19 grid inches (two 9.5-inch columns)
- Fits between studs
- ABS construction
- Flexi-mount system (slots and tabs allow for surface or flush mount)
- Electrical J-box knockout on bottom
- Eight combination 0.5" or 2" knockouts, including two located on the sides of the box
- Paint shield and four Phillips head screws included
- Snap-on vented cover included
- ETL Listed

H318

18" Enclosure

- ORDER # H318



The Model H318 18" Enclosure provides grid mounting space for Linear structured wiring components.

Features:

- HC18A: Optional enclosure cover (not shown)
- 18 inches high
- 33 grid inches (Two 16.5-inch columns)
- Fits between studs
- 16-Gauge all-metal construction
- Flexi-mount system (slots and tabs allow for surface or flush mount)
- New electrical knockout in bottom
- Eight knockouts, including two located on the side of the box
- Accepts H290 or H291 Power Accessory
- Optional H208 Lock available

HC18A

18" Enclosure Cover

- ORDER # HC18A



The Model HC18A 18" Enclosure Cover fits on the Model H318 Structured Wiring Enclosure. The ventilated enclosure cover secures and protects the structured wiring components mounted inside the Model H318 enclosure. The cover is powder-coated and painted bright white. The optional Model H208 Lock Kit can be installed on the cover for additional security.

Features:

- Secures and protects components inside the enclosure
- Bright white powder-coated paint finish
- Four louvered vents for enclosure cooling
- Accepts the Model H208 Lock Kit for additional security

Structured Wiring Enclosures 39

HD18 18" Hinged Door Depth Extension Kit

- ORDER # HD18



The Model HD18 18" Hinged Door Depth Extension Kit fits on the Model H318 Structured Wiring Enclosure. The ventilated enclosure cover secures and protects the structured wiring components mounted inside the Model H318 Enclosure. The hinged door increases the cabinet depth for larger power supplies and improved cooling.

The white cover has a smoked Plexiglas window with the Linear logo printed on it. The optional Model H208 Lock Kit can be installed on the cover for additional security.

Features:

- Secures and protects components inside the enclosure
- Adds depth to the cabinet, allowing room for larger components
- Improved cooling
- Accepts the Model H208 Lock Kit for additional security

H336 36" Enclosure

- ORDER # H336



The Model H336 36" Enclosure provides grid mounting space for Linear structured wiring components.

Features:

- HC36A: Optional enclosure cover (not shown)
- 36 inches high
- 69 grid inches (Two 34.5-inch columns)
- Fits between studs
- 16-Gauge all-metal construction
- Flexi-mount system (slots and tabs allow for surface or flush mount)
- New electrical knockout in bottom
- Eight knockouts, including two located on the side of the box
- Accepts H290 or H291 Power Accessory
- Optional H208 Lock available

HC36A 36" Enclosure Cover

- ORDER # HC36A



The Model HC36A 36" Enclosure Cover fits on the Model H336 Structured Wiring Enclosure. The ventilated enclosure cover secures and protects the structured wiring components mounted inside the Model H336 Enclosure. The cover is powder-coated and painted bright white. The optional Model H208 Lock Kit can be installed on the cover for additional security.

Features:

- Secures and protects components inside the enclosure
- Bright white powder-coated paint finish
- Six louvered vents for enclosure cooling
- Accepts the Model H208 Lock Kit for additional security

HD36 36" Hinged Door Depth Extension Kit

- ORDER # HD36

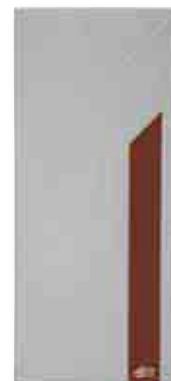

The Model HD36 36" Hinged Door Depth Extension Kit fits on the Model H336 Structured Wiring Enclosure. The ventilated enclosure cover secures and protects the structured wiring components mounted inside the Model H336 Enclosure. The hinged door increases the cabinet depth for larger power supplies and improved cooling.

The white cover has a smoked Plexiglas window. The optional Model H208 Lock Kit can be installed on the cover for additional security.

Features:

- Secures and protects components inside the enclosure
- Adds depth to the cabinet, allowing room for larger components
- Improved cooling
- Accepts the Model H208 Lock Kit for additional security

40 Structured Wiring Enclosures

H200

Universal Mounting Bracket

- ORDER # H200



The Model H200 Universal Mounting Bracket is the smallest and most economical metal bracket for mounting Linear structured wiring modules. This bracket also provides an easy solution for mounting Linear's structured wiring modules inside another manufacturer's structured wiring enclosure containing an incompatible mounting grid. The H200 bracket is compatible with all Linear single-width structured wiring modules.

Features:

- 6.5" W x 10.25" H
- Ten grid inches available
- Vertical or horizontal mounting
- Surface mount over single-gang or double-gang J-boxes
- Can be used as an adapter for mounting Linear single-width modules inside other manufacturer's enclosures
- Optional cover Model H205

H205

Enclosure Cover

- ORDER # H205



The Model H205 Enclosure Cover creates a sturdy, all-metal enclosure by attaching to the Model H200 Universal Mounting Bracket.

Features:

- Fits Model H200 Enclosure
- Steel, powder-coated, bright white snap-on cover
- Includes locking screws

H008

18" Demo Cover

- ORDER # H008



Clear plastic cover for H318 enclosure

H011

36" Demo Cover

- ORDER # H011



Clear plastic cover for H336 enclosure

Structured Wiring Accessories 41

H290 4-Duplex Outlet AC Power Accessory

- ORDER # H290



Features:

- Eight outlets (four dual-plug, single-gang outlets)
- Fits H318 or H336 enclosures
- Mounts at the top, bottom, left, or right of enclosure
- Outlets not included

H291 2-Duplex Outlet AC Power Accessory

- ORDER # H291



Features:

- Four outlets (two dual-plug, single-gang outlets)
- Fits H318 or H336 enclosures
- Mounts at the top, bottom, left, or right of enclosure
- Outlets not included

H270 Wire Spacer

- ORDER # H270



Features:

- Wire spacer—enclosure accessory
- Connects to the grid pattern on H318 and H336 enclosures
- Lifts modules one inch above grid
- Adds wire management capability
- Increases usable space

2619 Rack Mount Grid

- ORDER # 2619

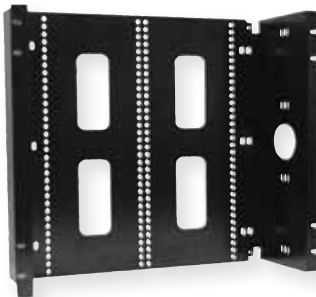

Features:

- Fits 19" EIA racks
- Ten spaces high and five inches deep
- Can be surface mounted with 0.5-inch clearance
- Compatible with Linear grid mount products

2620 Rack Mount Adapter for Modulators

- ORDER # 2620



Features:

- 19" rack adapter for Linear modulators
- Modulator firmly locks in place
- Uses one rack space

H275 Universal Mounting and Wire Management Bracket

- ORDER # H275



Features:

- Provides 26 grid spaces for mounting Linear structured wiring modules
- Connects to the grid pattern vertically or horizontally on the H318 or H336 structured wire enclosures
- Mounts vertically or horizontally inside most 14" or larger industry-standard structured wire enclosures
- Lifts Linear structured wiring modules one inch above mounting grid
- Adds wire management capability while increasing usable space
- Mounts vertically or horizontally directly onto a backboard or wall

MB-56 Universal Half-Width Grid Mounting Bracket

- ORDER # MB-56



Features:

- 6.25" wide
- White powder-coated finish
- Double-sided tape included for attaching devices to the bracket
- Plunger snap-lock secures bracket to the mounting grid

MB-55 Universal Full-Width Grid Mounting Bracket

- ORDER # MB-55

Features:

- 12.5" wide
- White powder-coated finish
- Double-sided tape included for attaching devices to the bracket
- Plunger snap-lock secures bracket to the mounting grid

42 Structured Wiring Accessories

H000 Replacement Snap Locks (10-pack)

• ORDER # H000



Used to replace any broken Linear grid mounting snap locks

H001 Universal Grid Mount Kit (12-pack)

• ORDER # H001



Allows non-Linear modules to be fastened to the Linear grid

H208 Lock Kit

• ORDER # H208



Allows the locking of Linear enclosures with a key to provide additional security; fits HC18A, HC36A, HD18, and HD36

H271 Coupling Tube

• ORDER # H271



Enclosure accessory for connecting two enclosures 2" apart, 2" conduit size

H272 Snap-In Grommets (5-pack)

• ORDER # H272



Provides wire protection from the sharp metal edges of the 2" enclosure knockouts

H281 Adapter

• ORDER # H281



Creates a mounting surface to attach keystone-style telephone, data, and coax barrel connectors (connectors not included) to the Linear mounting grid

H282 Isolation Mounting Bracket

• ORDER # H282



Heavy-duty bracket that allows mounting other products onto the Linear mounting grid

H283 Isolation Mounting Bracket

• ORDER # H283



Light-duty bracket that allows mounting other products onto the Linear mounting grid

H691 Cat-5e Patch Cord (1-Foot)

• ORDER # H691



1-Foot patch cord with RJ-45 modular plugs on both ends; Cat-5e compliant; wired in the T-568A standard

H692 Cat-5e Patch Cord (2-Foot)

• ORDER # H692



2-Foot patch cord with RJ-45 modular plugs on both ends; Cat-5e compliant; wired in the T-568A standard

Total Access Port Wall Plates 43

WPX-PDC Data/Telephone/Coax TAP Wall Plate

- ORDER # WPA-PDC (Almond)
- ORDER # WPA-PDC-10 (10-PACK) (Almond)
- ORDER # WPI-PDC (Ivory)
- ORDER # WPI-PDC-10 (10-PACK) (Ivory)
- ORDER # WPW-PDC (White)
- ORDER # WPW-PDC-10 (10-PACK) (White)



Features:

- Decora®-compatible design
- Our most versatile wall plate design
- One Cat-5e RJ-45 jack, two breakout RJ-25 telephone jacks, and two knockouts for use with coax barrel connectors (connectors included)
- Includes two 110 punch-down blocks for termination and two coax barrel connectors

WPX-PC Telephone/Coax TAP Wall Plate

- ORDER # WPA-PC (Almond)
- ORDER # WPA-PC-10 (10-PACK) (Almond)
- ORDER # WPI-PC (Ivory)
- ORDER # WPI-PC-10 (10-PACK) (Ivory)
- ORDER # WPW-PC (White)
- ORDER # WPW-PC-10 (10-PACK) (White)



Features:

- Decora®-compatible design
- Four RJ-25 telephone jacks
- Breaks out each telephone line to an individual jack
- Provisions for two coax barrel connectors (connectors included)
- Includes one 110 punch-down block plus two coax barrel connectors

WPX-DD Dual Data TAP Wall Plate

- ORDER # WPA-DD (Almond)
- ORDER # WPA-DD-10 (10-PACK) (Almond)
- ORDER # WPI-DD (Ivory)
- ORDER # WPI-DD-10 (10-PACK) (Ivory)
- ORDER # WPW-DD (White)
- ORDER # WPW-DD-10 (10-PACK) (White)



Features:

- Decora®-compatible design
- Includes two 110 punch-down blocks for termination
- Two Cat-5e RJ-45 connectors

WPX-DP Data/Telephone TAP Wall Plate

- ORDER # WPA-DP (Almond)
- ORDER # WPA-DP-10 (10-PACK) (Almond)
- ORDER # WPI-DP (Ivory)
- ORDER # WPI-DP-10 (10-PACK) (Ivory)
- ORDER # WPW-DP (White)
- ORDER # WPW-DP-10 (10-PACK) (White)



Features:

- Decora®-compatible design
- Single Cat-5e RJ-45 jack and four RJ-25 telephone jacks
- Breaks out each telephone line to an individual jack
- Includes two 110 punch-down blocks for termination

44 Music Distribution Systems

MDS-6A

Music Distribution System

- ORDER # MDS-6A



Features:

- Six audio sources selectively switched to six speaker zones
- 12 channels (six left and right pairs) x 40 watts per channel amplifier power
- Front panel speaker zone on/off status indicators
- Removable speaker terminals with wire lock levers (no tools required)
- User feedback to all backlit system keypads
- RJ-45 connection to each keypad with Cat-5 cable
- IR target built into each keypad
- IR remote control of audio sources with six source-specific routed IR output ports
- Frequency response 20 Hz to 20 kHz ± 1 dB
- Total harmonic distortion @ 1 kHz 0.02%
- Signal-to-noise ratio greater than 95 dB
- Zone-to-zone crosstalk isolation greater than 70 dB
- Size: 17" W x 12.5" D x 4" H
- Weight: 21 lbs.

MDS-6A

KIT #1

- ORDER # MDS-6A KIT #1



The Model MDS-6A Kit #1 Music Distribution System Kit offers the basic components needed to assemble a 6-room music distribution system. The kit includes the following:

- (1) – Model MDS-6A Music Distribution System Amplifier
- (4) – Model MCS-1A Speaker Zone Control Keypads
- (2) – Model MCS-2A Multi-function Speaker Zone Control Keypads
- (6) – Model 2171 Single-head IR Emitters

The kit provides six rooms of amplified music distribution from the Model MDS-6A Amplifier, four basic speaker zone controllers with the Model MCS-1A Keypads, two full-featured speaker zone controllers with model MCS-2A keypads and IR control of six audio source components with the Model 2171 Single-head IR Emitters.

MDS-6A

KIT #2

- ORDER # MDS-6A KIT #2



The Model MDS-6A Kit #2 Music Distribution System Kit offers the basic components needed to assemble a 6-room music distribution system. The kit includes the following:

- (1) – Model MDS-6A Music Distribution System Amplifier
- (6) – Model MCS-1A Speaker Zone Control Keypads
- (6) – Model 2171 Single-head IR Emitters

The kit provides six rooms of amplified music distribution from the Model MDS-6A Amplifier, six basic speaker zone controllers with the Model MCS-1A Keypads, and IR control of six audio source components with the Model 2171 Single-head IR Emitters.

Music Distribution Systems 45

MCS-1A

Speaker Zone Control Keypad

- ORDER # MCS-1A



Features:

- Single-gang mounting
- Connects via RJ-45 connector
- Fits Decora®-style wall plate
- Allows selection of any audio source
- Allows volume up/down and mute per each zone
- Multi-colored, backlit LED keys
- Full IR pass through
- Customizable button tops
- Keypad bezel provided in white and ivory
- Multiple units can be used in the same zone

MCS-2A Multi-Function Speaker Zone Control Keypad

- ORDER # MCS-2A



Features:

- Double-gang mounting
- Connects via RJ-45 connector
- Fits Decora®-style wall plate
- Allows selection of any audio source
- Allows volume up/down and mute per each zone
- Multi-colored, backlit keys
- Full IR pass through
- Customizable button tops
- Keypad bezel provided in white and ivory
- Multiple units can be used in the same zone
- Programmable transport buttons (Play, Stop, Pause, etc.)
- Can learn up to 25 macros with ten steps each
- User-assignable delays for macros
- Data cloning between keypads
- Extensive on-board IR code library simplifies source IR code programming

MDS6A-REM

Remote Control for MDS-6A

- ORDER # MDS6A-REM



Features:

- IR target built into each keypad
- IR remote control of audio sources with six source-specific routed IR output ports

MDS-LLK

Line Level Adapter

- ORDER # MDS-LLK



Features:

- Stereo speaker level inputs
- Stereo line level outputs
- Adjustable balance control

MDS-PCK

6x12 Patch Cord Kit

- ORDER # MDS-PCK



Features:

- Connect up to six audio sources to two MDS-6A Amplifiers for 12-zone distribution
- Supports stereo (left and right) audio signals
- IR remote control of audio source components from both MDS-6A Amplifiers
- Color coded

46 Music Distribution Systems

XDM4600KIT

Music Distribution System Kit

- ORDER # XDM4600KIT



Features:

- Four XDM46K Keypads and one DS3BS Door Speaker included
- XDM46CC Central Controller and XDM46R Remote Control included
- 20 Hz to 20 kHz frequency response
- 0.2% maximum total harmonic distortion
- 95 db minimum signal-to-noise ratio
- Central controller powered from 120 VAC
- Class D digital amplifier in each speaker zone keypad with 60 watts output power
- IR receiver built into each keypad; IR repeater in controller
- Four speaker zones expandable to eight speaker zones
- Keypad intercom privacy feature
- Keypads mount in standard double-gang J-boxes

XDM46EH Music Distribution System Expansion Hub

- ORDER # XDM46EH



Features:

- Expands XDM system to up to eight speaker zones
- 20 Hz to 20 kHz frequency response
- 0.2% maximum total harmonic distortion
- 95 db minimum signal-to-noise ratio
- Expansion hub powered from 120 VAC
- Class D digital amplifier in each speaker zone keypad with 60 watts output power
- IR receiver built into each keypad; IR repeater in controller
- Keypad intercom privacy feature

Music Distribution Systems 47

XDM46K

Music Distribution System Keypad

- ORDER # XDM46K



Features:

- 20 Hz to 20 kHz frequency response
- 0.2% maximum total harmonic distortion
- 95 db minimum signal-to-noise ratio
- Class D digital amplifier in each speaker zone keypad with 60 watts output power
- IR receiver built into each keypad; IR repeater in controller
- Keypad intercom privacy feature
- Keypad mounts in double-gang J-box

XDM46R Music Distribution System Remote Control

- ORDER # XDM46R



Features:

- Infrared remote control for XDM system
- Remote can learn codes from other remotes
- Large LCD display
- Source component display names can be customized
- Programmable macros with up to 20 steps each
- Powered by four AAA batteries
- Low-battery indicator

XDMWP Music Distribution System Audio Input Wall Plate

- ORDER # XDMWP



Features:

- Local audio input wall plate for XDM46K Keypad
- White wall plate faceplate
- Connects local line-level stereo or monaural audio source
- Line-level stereo audio output jacks for subwoofer or loop-through
- Wall plate mounts in single-gang J-box

DS3B2

XDM System Intercom Door Station with Bell Button

- ORDER # DS3B2



Features:

- White faceplate
- Lighted doorbell button
- 2-Way voice communications
- Mounts in Model ME3 Door Station Rough-in Enclosure

48 Music Distribution Systems

XDM46KAF Music Distribution System Keypad Color Kit (4-pack) (Almond)

- ORDER # XDM46KAF

Features:

- Almond-colored faceplates and wall plates
- Changes keypad color or replaces damaged or worn keypad components
- Fits XDM46K Keypads
- Four sets included in each kit



XDM46KBF Music Distribution System Keypad Color Kit (4-pack) (Black)

- ORDER # XDM46KBF

Features:

- Black-colored faceplates and wall plates
- Changes keypad color or replaces damaged or worn keypad components
- Fits XDM46K Keypads
- Four sets included in each kit



Music Distribution Systems 49

XDMCKIT Music Distribution System Replacement Connector Kit

- ORDER # XDMCKIT



Features:

- Plug-in screw terminal connectors for XDM46CC and XDM46EH
- Eight 4-position speaker zone keypad data connectors
- Two 8-position speaker zone keypad power connectors
- One 8-position door speaker data/power connector

XDMIRE Music Distribution System Replacement Emitter Kit

- ORDER # XDMIRE



Features:

- Six infrared emitters for controlling source components
- Emitters for replacement or re-work purposes
- Adhesive backing on emitters for placing over source component IR receiver window
- 10-Foot cable and mini-plug on each emitter

50 4-Ohm Speakers

MNC

Mini-Cube Speaker Pair

- ORDER # MNC



The Model MNC Mini-cube Speaker Pair are 4-ohm, 70-watt, dual-pivoting indoor cube speakers. Each speaker has two pivoting cubes, each containing a 2.5-inch paper cone with a rubber surround speaker covered with a metal grille. The mini-cubes can be mounted on the wall or ceiling, or be used freestanding.

The speaker frequency response is 250 Hz to 15 kHz, and the magnets are shielded for home theater use near monitors. The speaker pair is supplied with hanger brackets.

Features:

- White-colored cube speakers
- Pair of speakers, each with dual 2.5-inch drivers
- 4-Ohm impedance
- 70 watts maximum power
- 250 Hz to 15 kHz frequency response
- Hanger brackets included
- 3.5" W x 6.5" H x 4.5" D

MNCC

Center Channel Speaker

- ORDER # MNCC



The Model MNCC Center Channel Speaker is a 4-ohm, 70-watt, 2-way, dual-speaker, home theater center channel speaker. The speaker has two 4-inch woofers, a 0.5-inch tweeter, and a metal grille.

The speaker frequency response is 250 Hz to 15 kHz, and the magnets are shielded for home theater use near monitors.

Features:

- Black-colored center channel speaker
- Dual 4-inch woofers, 0.5-inch tweeter
- 4-Ohm impedance
- 70 watts maximum power
- 250 Hz to 15 kHz frequency response
- 14.5" W x 5.438" H x 5.875" D

MNCS Mini-Cube Home Theater Speaker Package

- ORDER # MNCS



The Model MNCS Mini-cube Home Theater Speaker Package is a complete speaker package for creating a home theater system.

The following speakers are included in this package:

- (2) - MNC Mini-cube Speaker Pairs (White)
- (1) - MNCC Center Channel Speaker (Black)
- (1) - PSW108 Powered Subwoofer (Black)

Features:

- Complete home theater speaker package
- Four white, magnetically shielded 70-watt cube speakers
- One black, magnetically shielded 70-watt center channel speaker
- One black, 100-watt down-firing 8-inch powered subwoofer

8-Ohm Speakers 51

MNCX Mini-Cube Platinum Speaker Pair (White)

• ORDER # MNCX



The Model MNCX Mini-cube Platinum Speaker Pair (White) are 8-ohm, 100-watt, dual-pivoting indoor cube speakers. Each speaker has two pivoting cubes, each containing a 3-inch paper cone with a rubber surround speaker covered with a cloth grille. The mini-cubes can be mounted on the wall or ceiling, or be used freestanding.

The speaker frequency response is 150 Hz to 20 kHz, and the magnets are shielded for home theater use near monitors. The speaker pair is supplied with hanger brackets.

Features:

- White-colored cube speakers
- Pair of speakers, each with dual 3-inch drivers
- 8-Ohm impedance
- 100 watts maximum power
- 150 Hz to 20 kHz frequency response
- Hanger brackets included
- 4" W x 8.75" H x 4" D

MNCXB Mini-Cube Platinum Speaker Pair (Black)

• ORDER # MNCXB



The Model MNCXB Mini-cube Platinum Speaker Pair (Black) are 8-ohm, 100-watt, dual-pivoting indoor cube speakers. Each speaker has two pivoting cubes, each containing a 3-inch paper cone with a rubber surround speaker covered with a cloth grille. The mini-cubes can be mounted on the wall or ceiling, or be used freestanding.

The speaker frequency response is 150 Hz to 20 kHz, and the magnets are shielded for home theater use near monitors. The speaker pair is supplied with hanger brackets.

Features:

- Black-colored cube speakers
- Pair of speakers, each with dual 3-inch drivers
- 8-Ohm impedance
- 100 watts maximum power
- 150 Hz to 20 kHz frequency response
- Hanger brackets included
- 4" W x 8.75" H x 4" D

MNCXCB Platinum Center Channel Speaker

• ORDER # MNCXCB



The Model MNCXCB Platinum Center Channel Speaker is an 8-ohm, 100-watt, dual-speaker, home theater center channel speaker. The speaker has two 3-inch woofers with rubber surrounds and a cloth grille.

The speaker frequency response is 150 Hz to 20 kHz, and the magnets are shielded for home theater use near monitors.

Features:

- Black-colored center channel speaker
- Dual 3-inch woofers with rubber surrounds
- 8-Ohm impedance
- 100 watts maximum power
- 150 Hz to 20 kHz frequency response
- 9.5" W x 4" H x 4" D

52 8-Ohm Speakers

MNCXS Mini-Cube Platinum Home Theater Speaker Package (White)

• ORDER # MNCXS



The Model MNCXS Mini-cube Platinum Home Theater Speaker Package (White) is a complete speaker package for creating a home theater system. The following speakers are included in this package:

- (2) - MNCX Mini-cube Platinum Speaker Pairs (White)
- (1) - MNCXCB Platinum Center Channel Speaker (Black)
- (1) - PSW112 Platinum Powered Subwoofer (Black)

Features:

- Complete home theater speaker package
- Four white, magnetically shielded 100-watt cube speakers
- One black, magnetically shielded 100-watt center channel speaker
- One black, 100-watt down-firing 12-inch powered subwoofer

MNCXSB Mini-Cube Platinum Home Theater Speaker Package (Black)

• ORDER # MNCXSB



The Model MNCXSB Mini-cube Platinum Home Theater Speaker Package (Black) is a complete speaker package for creating a home theater system. The following speakers are included in this package:

- (2) - MNCXB Mini-cube Platinum Speaker Pairs (Black)
- (1) - MNCXCB Platinum Center Channel Speaker (Black)
- (1) - PSW112 Platinum Powered Subwoofer (Black)

Features:

- Complete home theater speaker package
- Four black, magnetically shielded 100-watt cube speakers
- One black, magnetically shielded 100-watt center channel speaker
- One black, 100-watt down-firing 12-inch powered subwoofer

MNCXSM Mini-Cube Platinum Home Theater Speaker Package (White & Black)

• ORDER # MNCXSM



The Model MNCXSM Mini-cube Platinum Home Theater Speaker Package (White & Black) is a complete speaker package for creating a home theater system. The following speakers are included in this package:

- (1) - MNCX Mini-cube Platinum Speaker Pair (White)
- (1) - MNCXB Mini-cube Platinum Speaker Pair (Black)
- (1) - MNCXCB Platinum Center Channel Speaker (Black)
- (1) - PSW112 Platinum Powered Subwoofer (Black)

Features:

- Complete home theater speaker package
- Two white, magnetically shielded 100-watt cube speakers
- Two black, magnetically shielded 100-watt cube speakers
- One black, magnetically shielded 100-watt center channel speaker
- One black, 100-watt down-firing 12-inch powered subwoofer

8-Ohm Speakers 53

PSW108

Powered Subwoofer

- ORDER # PSW108



The Model PSW108 Powered Subwoofer is a down-firing 8-inch powered subwoofer with a built-in 100-watt amplifier. The PSW108 has a frequency response from 40 Hz to 300 Hz. An adjustable volume control is provided to set the subwoofer's bass level.

This subwoofer has both line-level and speaker-level stereo inputs with loop-through connections for both. The line-level inputs and outputs are female RCA connectors. The speaker level inputs and outputs are spring-loaded press-down terminals.

The subwoofer is powered from a 120-VAC source and contains automatic power switching circuitry. The auto-power feature will turn on the subwoofer's amplifier when an audio input signal is detected. The amplifier will power down a few minutes after the audio input signal stops. The automatic power feature can be switched off to have the subwoofer's amplifier powered constantly.

The adjustable crossover frequency control sets the upper frequency range of the subwoofer. It can be adjusted 40 Hz to 140 Hz to suit the lower frequency capabilities of the other speakers in the system. A crossover bypass switch is included to extend the high-end frequency response of the subwoofer to approximately 350 Hz. The subwoofer phase switch controls the speaker's polarity and can be set to match the phase of the other speakers in the system for the loudest bass.

Features:

- Black-colored subwoofer
- 8-Inch down-firing speaker
- 100 watts RMS maximum power output
- 40 Hz to 350 Hz frequency response
- Line-level inputs and speaker-level inputs
- 8-Ohm impedance on speaker-level inputs
- All inputs have loop-through outputs
- Adjustable high-pass crossover 40 Hz to 140 Hz
- Crossover bypass, automatic power, and speaker phase switch
- Volume control
- Powered from 120 VAC with optional automatic amplifier power switching
- 9.188" W x 13.313" H x 13.688" D

PSW112

Platinum Powered Subwoofer

- ORDER # PSW112



The Model PSW112 Powered Subwoofer is a down-firing 12-inch powered subwoofer with a built-in 100-watt amplifier. The PSW112 has a frequency response from 30 Hz to 140 Hz. An adjustable volume control is provided to set the subwoofer's bass level.

This subwoofer has both line-level and speaker-level stereo inputs with loop-through connections for both. The line-level inputs and outputs are female RCA connectors. The speaker level inputs and outputs are spring-loaded press-down terminals.

The subwoofer is powered from a 120-VAC source and contains automatic power switching circuitry. The auto-power feature will turn on the subwoofer's amplifier when an audio input signal is detected. The amplifier will power down a few minutes after the audio input signal stops. The automatic power feature can be switched off to have the subwoofer's amplifier powered constantly.

The adjustable crossover frequency control sets the upper frequency range of the subwoofer. It can be adjusted 40 Hz to 140 Hz to suit the lower frequency capabilities of the other speakers in the system. A crossover bypass switch is included to extend the high-end frequency response of the subwoofer to approximately 300 Hz. The subwoofer phase switch controls the speaker's polarity and can be set to match the phase of the other speakers in the system for the loudest bass.

Features:

- Black-colored subwoofer
- 12-Inch down-firing speaker
- 100 watts RMS maximum power output
- 30 Hz to 140 Hz frequency response
- Line-level inputs and speaker-level inputs
- 8-Ohm impedance on speaker-level inputs
- All inputs have loop-through outputs
- Adjustable high-pass crossover 40 Hz to 140 Hz
- Crossover bypass, automatic power, and speaker phase switch
- Volume control
- Powered from 120 VAC with optional automatic amplifier power switching
- 14" W x 15.75" H x 16" D

54 8-Ohm Speakers

WG100C

WG Series Ceiling Speaker Pair

• ORDER # WG100C



The Model WG100C WG Series Ceiling Speaker Pair are 8-ohm, 100-watt, 2-way in-ceiling speakers. Each speaker has a 6.5-inch Kevlar cone woofer with butyl rubber surround, a 1-inch aluminum dome swivel tweeter, and a white aluminum grille. The unique WG Series horn-shaped speaker baffle is designed for superior sound dispersion.

The speaker frequency response is 50 Hz to 20 kHz. Two 3-position ± 3 db switches allow customization of the woofer and tweeter levels to best suit the installation. The swivel tweeter permits pointing the tweeter toward the listening area to pinpoint the high-frequency sound.

The speakers mount using a rubber-padded cam-lock system. The cam-lock tabs swing out behind the speaker and tighten down to secure the speaker to the mounting surface. The Model MR6C Ceiling Speaker Mounting Ring Pair is required to install these speakers.

High-quality, spring-loaded, gold-plated speaker wire terminals ensure good electrical connection. The grille and frame can be painted if necessary.

Features:

- In-ceiling speaker pair
- White aluminum grille
- Cam-lock rubber-padded mounting system
- 6.5-Inch Kevlar woofer, 1-inch aluminum dome swivel tweeter
- 8-Ohm impedance
- 100 watts maximum power
- 50 Hz to 20 kHz frequency response
- 9" diameter frame

WG100W

WG Series In-Wall Speaker Pair

• ORDER # WG100W



The Model WG100W WG Series In-wall Speaker Pair are 8-ohm, 100-watt, 2-way in-wall speakers. Each speaker has a 6.5-inch Kevlar cone woofer with butyl rubber surround, a 1-inch aluminum dome swivel tweeter, and a white aluminum grille. The unique WG Series horn-shaped speaker baffle is designed for superior sound dispersion.

The speaker frequency response is 50 Hz to 20 kHz. Two 3-position ± 3 db switches allow customization of the woofer and tweeter levels to best suit the installation. The swivel tweeter permits pointing the tweeter toward the listening area to pinpoint the high-frequency sound.

The speakers mount using a rubber-padded cam-lock system. The cam-lock tabs swing out behind the speaker and tighten down to secure the speaker to the mounting surface. The speaker separates from its frame for easy installation. A Model MR6W Wall Speaker Mounting Ring Pair is required for these speakers. An IR lens is built into the speaker's baffle for mounting an infrared remote control receiver behind the speaker grille. High-quality, spring-loaded, gold-plated speaker wire terminals ensure good electrical connection. The grille and frame can be painted if necessary.

Features:

- In-wall speaker pair
- White aluminum grille
- Cam-lock rubber-padded mounting system
- 6.5-Inch woofer, 1-inch swivel tweeter
- 8-Ohm impedance
- 100 watts maximum power
- 50 Hz to 20 kHz frequency response
- 9" W x 12.313" H

8-Ohm Speakers 55

WG150C

WG Series Ceiling Speaker Pair

- ORDER # WG150C



The Model WG150C WG Series Ceiling Speaker Pair are 8-ohm, 150-watt, 2-way in-ceiling speakers. Each speaker has an 8-inch Kevlar cone woofer with butyl rubber surround, a 1-inch aluminum dome swivel tweeter, and a white aluminum grille. The unique WG Series horn-shaped speaker baffle is designed for superior sound dispersion.

The speaker frequency response is 35 Hz to 20 kHz. Two 3-position ± 3 db switches allow customization of the woofer and tweeter levels to best suit the installation. The swivel tweeter permits pointing the tweeter toward the listening area to pinpoint the high-frequency sound.

The speakers mount using a rubber-padded cam-lock system. The cam-lock tabs swing out behind the speaker and tighten down to secure the speaker to the mounting surface. The Model MR8C Ceiling Speaker Mounting Ring Pair is required to install these speakers.

High-quality, spring-loaded, gold-plated speaker wire terminals ensure good electrical connection. The grille and frame can be painted if necessary.

Features:

- In-ceiling speaker pair
- White aluminum grille
- Cam-lock rubber-padded mounting system
- 8-Inch Kevlar woofer, 1-inch aluminum dome swivel tweeter
- 8-Ohm impedance
- 150 watts maximum power
- 35 Hz to 20 kHz frequency response
- 10.875" diameter frame

WG150W

WG Series In-Wall Speaker Pair

- ORDER # WG150W



The Model WG150W WG Series In-wall Speaker Pair are 8-ohm, 150-watt, 2-way in-wall speakers. Each speaker has an 8-inch Kevlar cone woofer with butyl rubber surround, a 1-inch aluminum dome swivel tweeter, and a white aluminum grille. The unique WG Series horn-shaped speaker baffle is designed for superior sound dispersion.

The speaker frequency response is 35 Hz to 20 kHz. Two 3-position ± 3 db switches allow customization of the woofer and tweeter levels to best suit the installation. The swivel tweeter permits pointing the tweeter toward the listening area to pinpoint the high-frequency sound.

The speakers mount using a rubber-padded cam-lock system. The cam-lock tabs swing out behind the speaker and tighten down to secure the speaker to the mounting surface. The speaker separates from its frame for easy installation. A Model MR8W Wall Speaker Mounting Ring Pair is required for these speakers.

An IR lens is built into the speaker's baffle for mounting an infrared remote control receiver behind the speaker grille. High-quality, spring-loaded, gold-plated speaker wire terminals ensure good electrical connection. The grille and frame can be painted if necessary.

Features:

- In-wall speaker pair
- White aluminum grille
- Cam-lock rubber-padded mounting system
- 8-Inch woofer, 1-inch swivel tweeter
- 8-Ohm impedance
- 150 watts maximum power
- 35 Hz to 20 kHz frequency response
- 10.25" W x 14.938" H

56 8-Ohm Speakers

FSHW Indoor/Outdoor Speaker Pair (White)

• ORDER # FSHW



Features:

- White-colored cube speakers
- 8-Ohm impedance
- 50 watts maximum power
- Pair of 2-way speakers with 4-inch woofers and 0.5-inch tweeters
- 100 Hz to 18 kHz frequency response
- Hanger brackets and hardware included
- 8" W x 5.25" H x 4.5" D

FSHWB Indoor/Outdoor Speaker Pair (Black)

• ORDER # FSHWB



Features:

- Black-colored cube speakers
- 8-Ohm impedance
- 50 watts maximum power
- Pair of 2-way speakers with 4-inch woofers and 0.5-inch tweeters
- 100 Hz to 18 kHz frequency response
- Hanger brackets and hardware included
- 8" W x 5.25" H x 4.5" D

ROCK8G Rock Speaker (Granite)

• ORDER # ROCK8G



Features:

- Granite-colored rock speaker
- 8-Ohm impedance
- 8-Inch woofer and 2.5-inch tweeter
- 100 watts maximum power
- 100 Hz to 20 kHz frequency response
- Weather-resistant for outdoor use

ROCK8R Rock Speaker (Rust)

• ORDER # ROCK8R



Features:

- Rust-colored rock speaker
- 8-Ohm impedance
- 8-Inch woofer and 2.5-inch tweeter
- 100 watts maximum power
- 100 Hz to 20 kHz frequency response
- Weather-resistant for outdoor use

WS5 Indoor/Outdoor Speaker Pair

• ORDER # WS5



Features:

- White cube speakers
- 8-Ohm impedance
- 70 watts maximum power
- Pair of 2-way speakers with 5-1/4-inch woofers and 1-inch titanium dome tweeters
- 65 Hz to 20 kHz frequency response
- Hanger brackets and hardware included
- 7.25" W x 9.625" H x 6.5" W

S40C

Ceiling Speaker Pair

- ORDER # S40C

**Features:**

- In-ceiling speaker pair
- White metal grille
- Cam-lock mounting system
- 6.5-Inch woofer, 1-inch swivel tweeter
- 8-Ohm impedance
- 40 watts maximum power
- 60 Hz to 20 kHz frequency response
- 9" diameter x 3.375" D

S50C

Ceiling Speaker Pair

- ORDER # S50C

**Features:**

- In-ceiling speaker pair
- White metal grille
- Cam-lock mounting system
- 6.5-Inch woofer, 1-inch swivel tweeter
- 8-Ohm impedance
- 50 watts maximum power
- 50 Hz to 20 kHz frequency response
- 9" diameter x 3.375" D

S50CKIT

Ceiling Speaker Kit

- ORDER # S50CKIT

**Features:**

- In-ceiling speaker pair
- White metal grille
- Cam-lock mounting system
- 6.5-Inch woofer, 1-inch swivel tweeter
- 8-Ohm impedance
- 50 watts maximum power
- 50 Hz to 20 kHz frequency response
- Stereo volume control with white, Decora®-style wall plate included
- 9" diameter x 3.375" D

S50W

In-Wall Speaker Pair

- ORDER # S50W

**Features:**

- In-wall speaker pair
- White metal grille
- Cam-lock mounting system
- 6.5-Inch woofer, 1-inch swivel tweeter
- 8-Ohm impedance
- 50 watts maximum power
- 50 Hz to 16 kHz frequency response
- 8.625" W x 12" H x 3.375" D

58 8-Ohm Speakers

S100C

Ceiling Speaker Pair

• ORDER # S100C



Features:

- In-ceiling speaker pair
- White metal grille
- Cam-lock mounting system
- 8-Inch woofer, 1-inch swivel tweeter
- 8-Ohm impedance
- 100 watts maximum power
- 35 Hz to 20 kHz frequency response
- 10.75" diameter x 4.125" D

S100W

In-Wall Speaker Pair

• ORDER # S100W



Features:

- In-wall speaker pair
- White metal grille
- Cam-lock mounting system
- 6.5-Inch woofer, 0.875-inch swivel tweeter
- 8-Ohm impedance
- 100 watts maximum power
- 40 Hz to 20 kHz frequency response
- 8.625" W x 12" H x 3.625" D

PACKHTNS In-Wall Home Theater Speaker Package

• ORDER # PACKHTNS



The Model PACKHTNS In-wall Home Theater Speaker Package is a speaker package for creating an in-wall home theater system without a subwoofer.

The in-wall speakers are rated at 100 watts maximum power. The following speakers are included in this package:

- (5) - S100W In-wall Speakers
- (1) - HTWP Home Theater Wall Plate

Features:

- Home theater speaker package
- Five white, 100-watt in-wall speakers
- Home theater wall plate for connection to amplifier and speakers

Speaker Rough-In Mounting Rings

59

MR6C Ceiling Speaker Mounting Ring Pair

- ORDER # MR6C

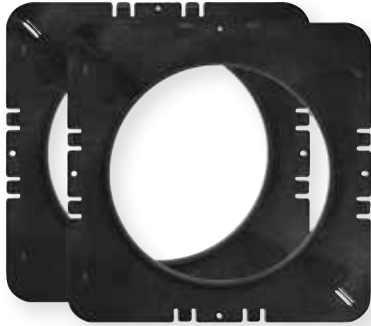

Pair of ceiling speaker mounting rings for 6-1/2" WG100C
WG Series Ceiling Speakers

MR6W In-Wall Speaker Mounting Ring Pair

- ORDER # MR6W

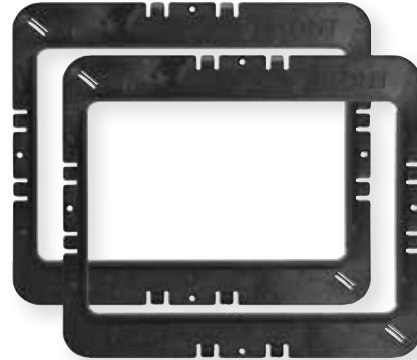

Pair of in-wall speaker mounting rings for 6-1/2" WG100W
WG Series In-wall Speakers

MR8C Ceiling Speaker Mounting Ring Pair

- ORDER # MR8C



Pair of ceiling speaker mounting rings for 8" WG150C
WG Series Ceiling Speakers

MR8W In-Wall Speaker Mounting Ring Pair

- ORDER # MR8W



Pair of in-wall speaker mounting rings for 8" WG150W
WG Series In-wall Speakers

60 Audio Wall Plates, Speaker & Volume Controls

SS1 Speaker Selector

- ORDER # SS1



Features:

- 6-Pair speaker selector
- Dual audio source capable with A/B switch; supports one or two amplifiers
- Impedance match switch to select the number of speaker pairs connected
- Constant 8-ohm load on amplifier regardless of number of speakers selected
- Isolated ground paths for left and right channels
- 100 watts maximum capacity per speaker channel
- Removable terminals support up to 12-gauge wire

IM1 Stereo Volume Control

- ORDER # IM1



Features:

- Stereo volume control
- Standard white wall plate
- Constant 8-ohm load on amplifier regardless of volume setting
- 75 watts maximum capacity
- Mounts in single-gang J-box

IM1D Stereo Volume Control with Decora® Wall Plate

- ORDER # IM1D (WHITE)
- ORDER # IM1DA (ALMOND)



Features:

- Stereo volume control
- Decora®-style wall plate
- Constant 8-ohm load on amplifier regardless of volume setting
- 75 watts maximum capacity
- Mounts in single-gang J-box

Audio Wall Plates, Speaker & Volume Controls 61

HTWP

Home Theater Wall Plate
(5.0 System)

- ORDER # HTWP



Features:

- Home theater wall plate for 5.0 speaker systems
- Terminates speaker wires
- Gold-plated binding posts connect to spade lugs, banana jacks, and bare wires
- Mounts in double-gang J-box

HTWP7

Home Theater Wall Plate
(7.1 System)

- ORDER # HTWP7



Features:

- Home theater wall plate for 7.1 speaker systems
- Terminates speaker wires
- Gold-plated binding posts connect to spade lugs, banana jacks, and bare wires
- Two RCA jacks for line-level amplified subwoofer
- Mounts in triple-gang J-box

WPW-D7.1

Home Theater Wall Plate
(7.1 System)

- ORDER # WPW-D7.1



Features:

- 18 gold-plated binding posts
- Red and black color-coded
- Two gold-plated RCA-to-F adapters for powered subwoofer applications
- Use the BLACK banana plugs for a professional-looking installation
- Fits double-gang J-box
- Available in white only

SL2

Single Speaker Wall Plate

- ORDER # SL2



Features:

- Wall plate for single speaker
- Terminates speaker wires
- Gold-plated binding posts connect to spade lugs, banana jacks, and bare wires
- Mounts in single-gang J-box

SL4

Dual Speaker Wall Plate

- ORDER # SL4



Features:

- Wall plate for two speakers
- Terminates speaker wires
- Gold-plated binding posts connect to spade lugs, banana jacks, and bare wires
- Mounts in single-gang J-box

62 Audio/Video Distribution Accessories

2743 Cable Set

• ORDER # 2743

The Model 2743 cable set has special RCA connectors that allow another set of cables to be connected directly to the RCAs on the Model 2743. This allows the signals to be looped through without the use of a Y adapter. The Model 2743 is ideal for use with the 5500 series modulators.



Features:

- 3-Conductor cable
- Supports stereo (left and right) audio and video signals
- Color coded

999-017-01 Power Supply

12 VDC @ 200mA

• ORDER # 999-017-01



Used with Model DA-520A

226888 Power Supply

12 VDC @ 2.5 Amps

• ORDER # 226888



Used with Model DMC-10H

219558 Power Supply

@ 12 VDC @ Two Amps

• ORDER # 219558



Used with Model SVD-8

350-086 Power Supply

15 VDC @ 300mA

• ORDER # 350-086



Used with Models 3015, 3025, 5415, 5425, 5435, DA-8200BID, DA-8200HHR, DA-506BID, DA-550BID, DA-550HHR

350-100 Power Supply

15 VDC @ 500mA

• ORDER # 350-100



Used with Models DA-500A, 5445, 5515, 5525

350-101 Power Supply

15 VDC @ 900mA

• ORDER # 350-101



Used with Model 5545

350-102 Power Supply

15 VDC @ 900mA

• ORDER # 350-102



Used with Models SVM-22, SVM-24

350-103 Power Supply

15 VDC @ 600mA

• ORDER # 350-103



Used with Models SVC-10, SVC-10R, SVS-52

HDTV Switching and Up-Scaling System

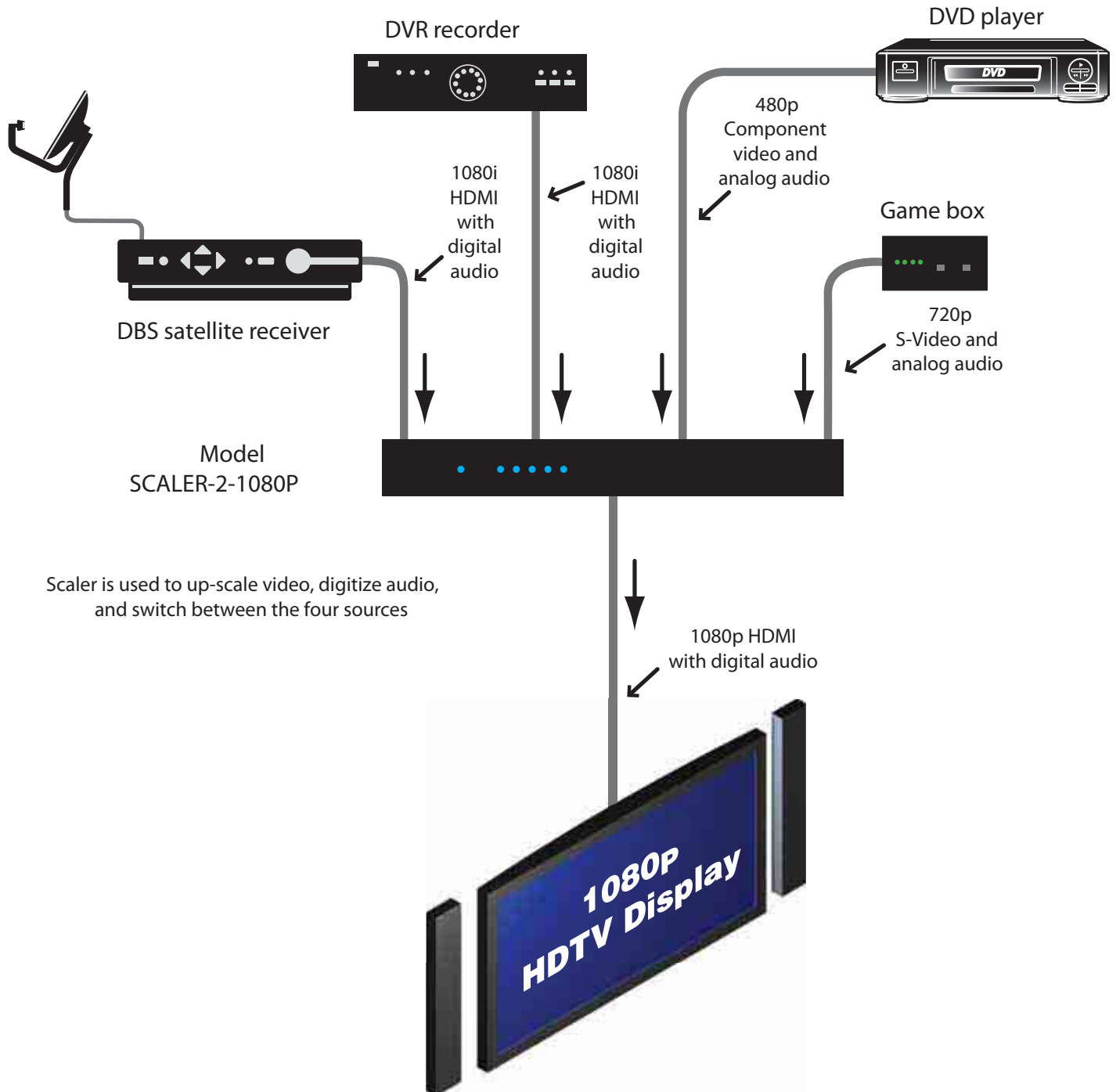

64 Application Diagrams

HDTV Switching, Up-Scale, and Extender System

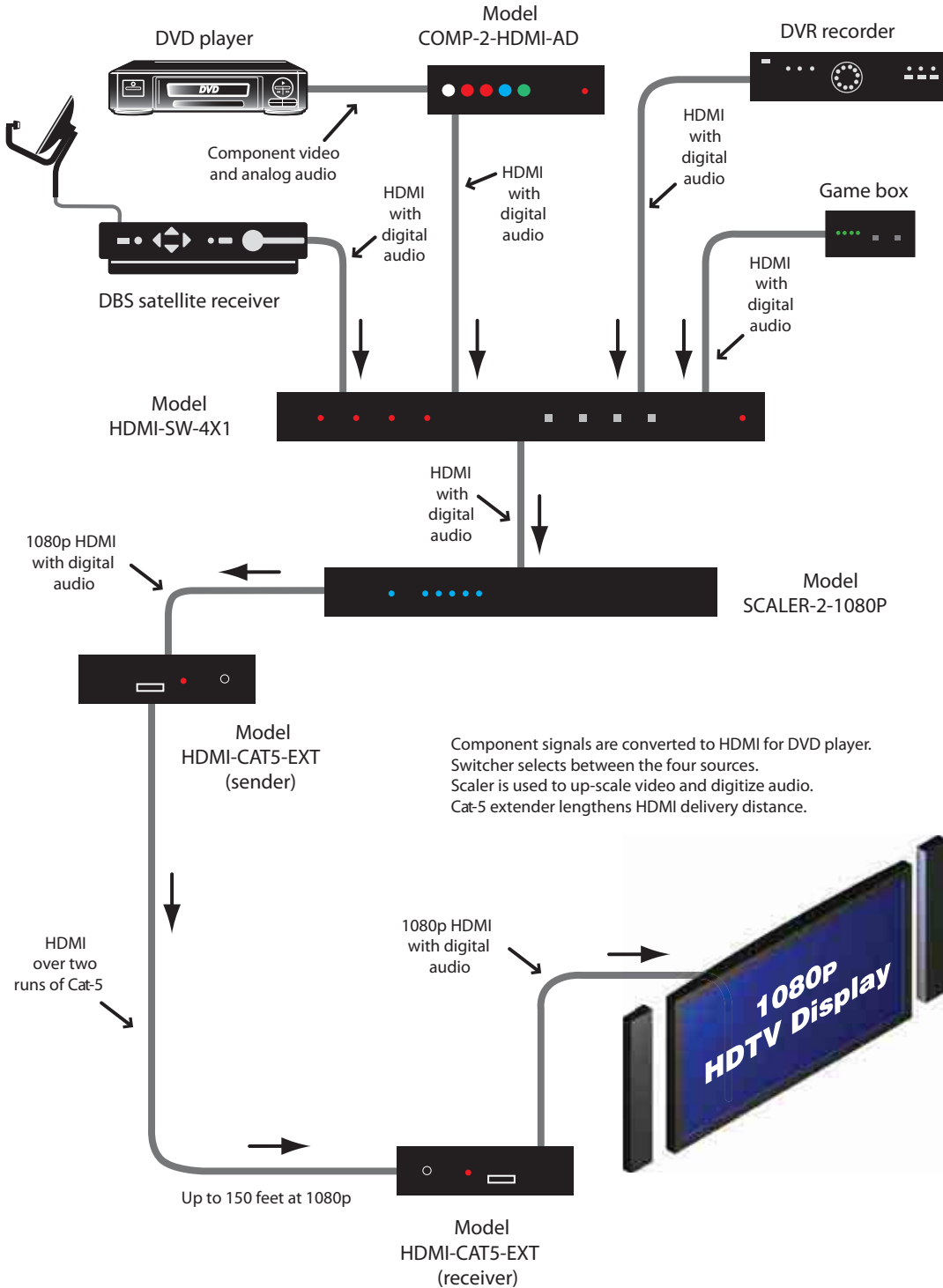

Large HDTV Distribution System

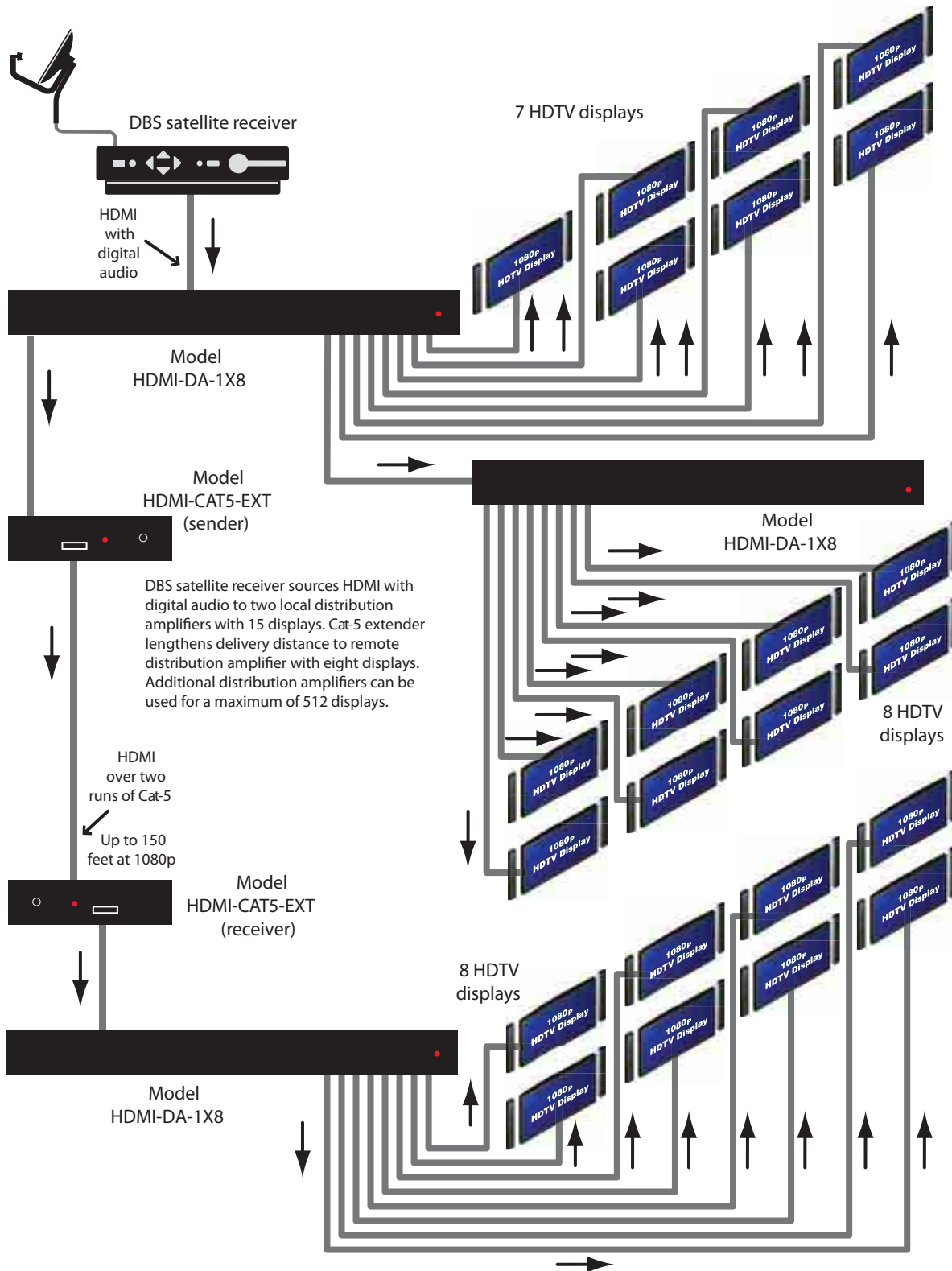

66 Application Diagrams

Connection Diagram for 5-Volt IR and DA-8200HHR

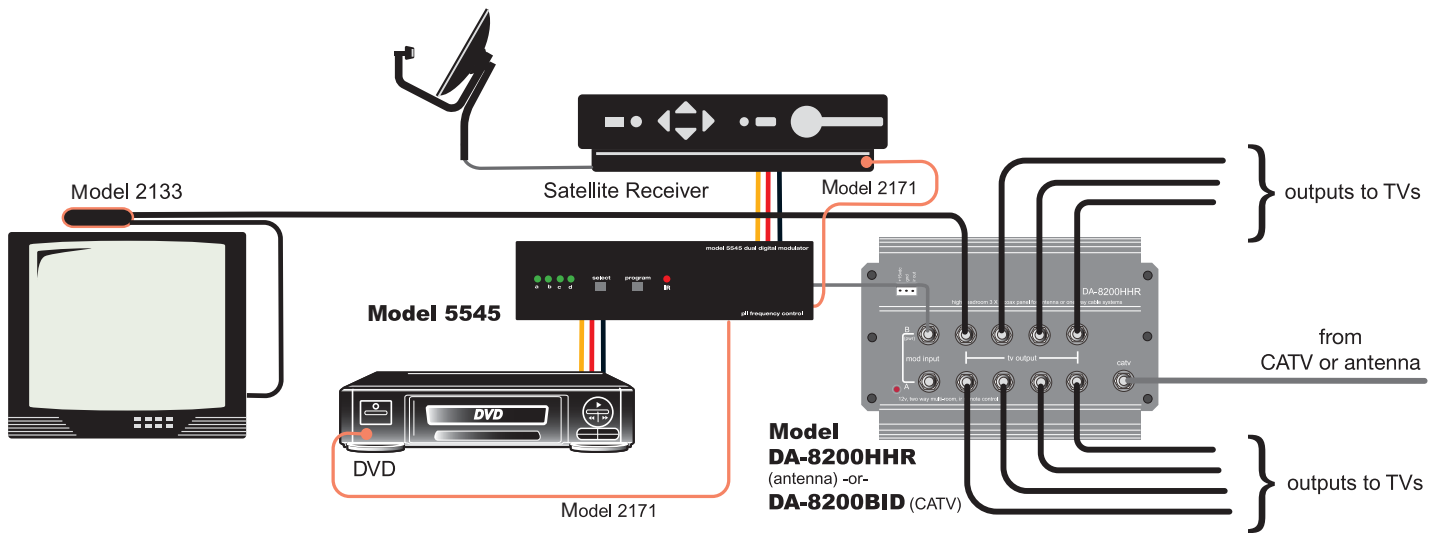

Accessories used with DA-8200HHR/BID:



Model 2133
5-volt Set-top Target



Model 2171
Single-head IR Emitter



Model 5545
4-channel Video Modulator with IR

Connection Diagram for 12-Volt IR and DA-550HHR

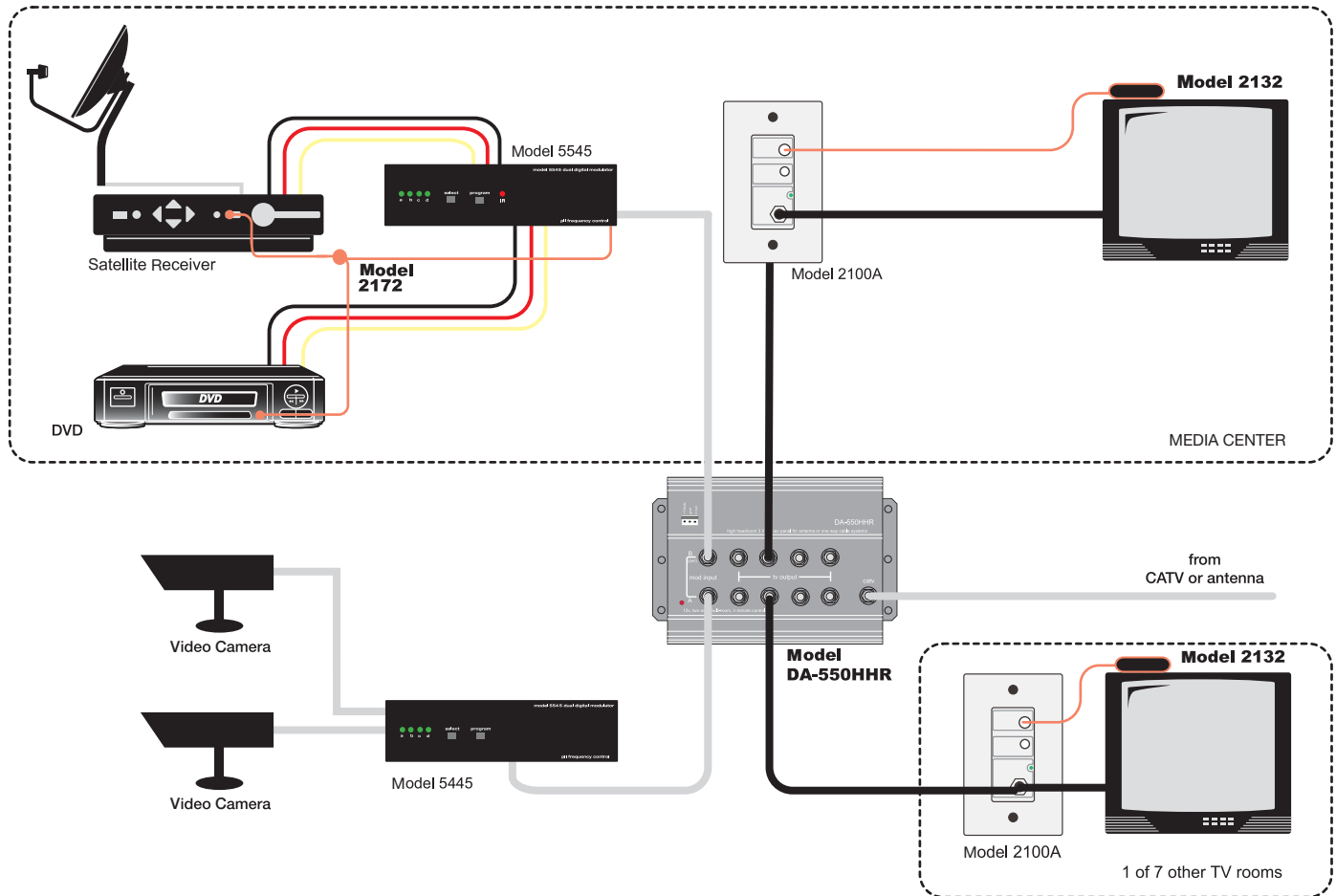

Accessories used with DA-550HHR/BID:



Model 2172
Dual-head IR Emitter



Model 2132
12-volt Set-top Target with Talk Back LED



Model 5545
4-channel Video Modulator with IR



Model 2100A
12-volt In-wall IR Interface

68 Application Diagrams

Connection Diagram for Model DA-500A

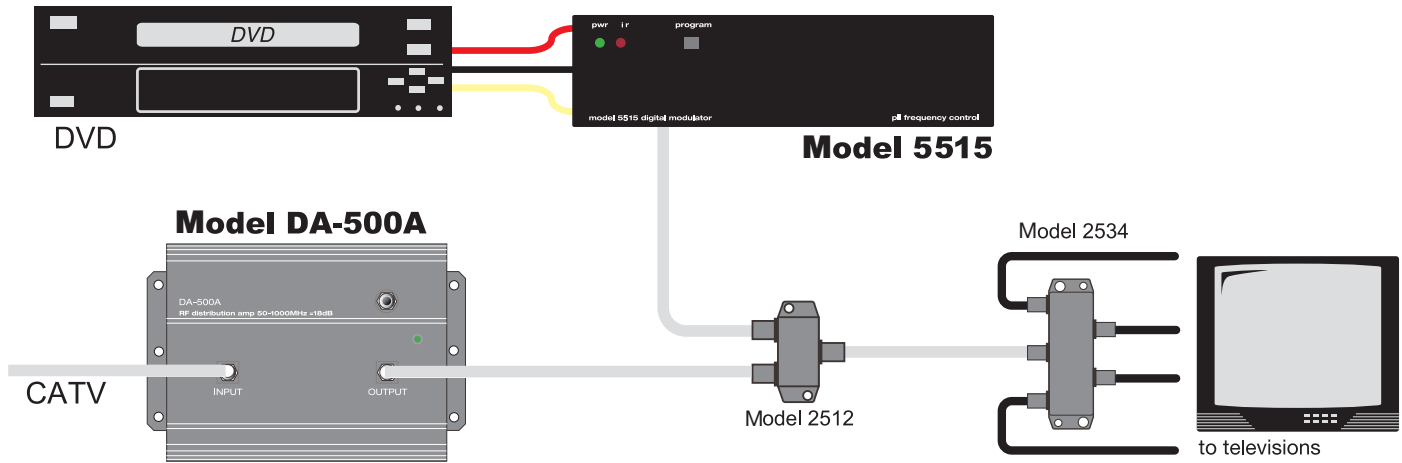

Accessories used with DA-500A:



Model 5515
1-channel Video Modulator with IR



Model 2512
DC & IR Passing 2-way Splitter/Combiner



Model 2534
4-way Splitter/Combiner

Connection Diagram for Model 5525

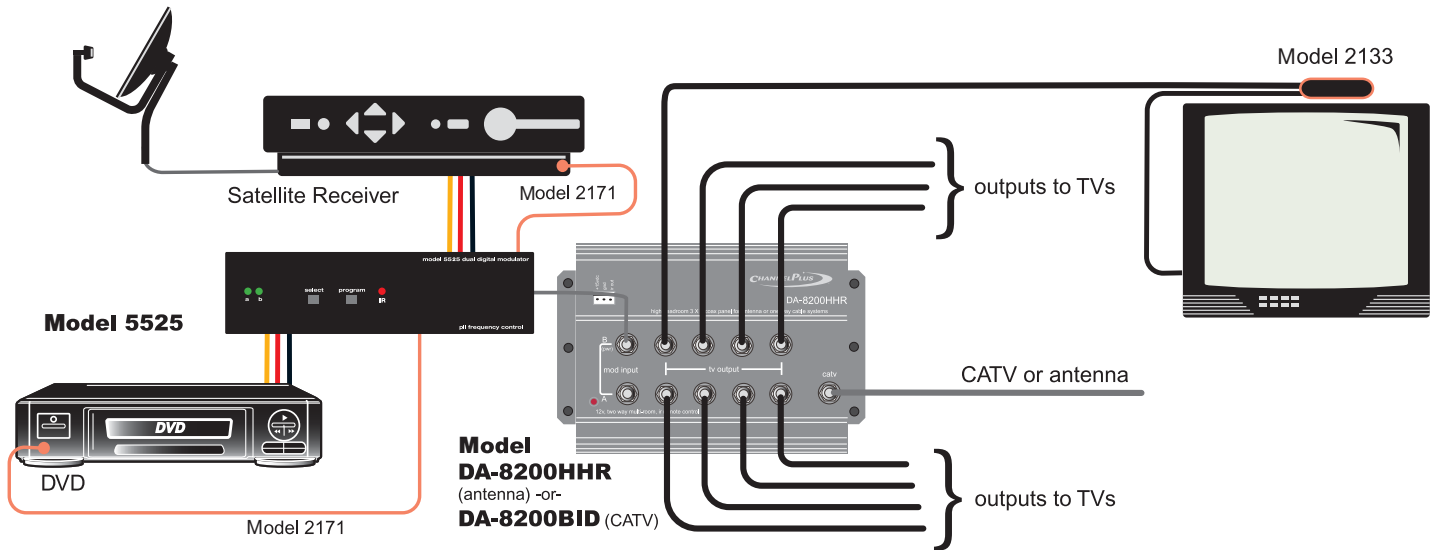

Accessories used with 5525:



Model 2171
Single-head IR Emitter



Model DA-8200HHR
High-headroom RF Distribution Amplifier
with 5-volt IR



Model 2133
5-volt Set-top Target

70 Application Diagrams

Connection Diagram for Model 5558 RF Distribution System

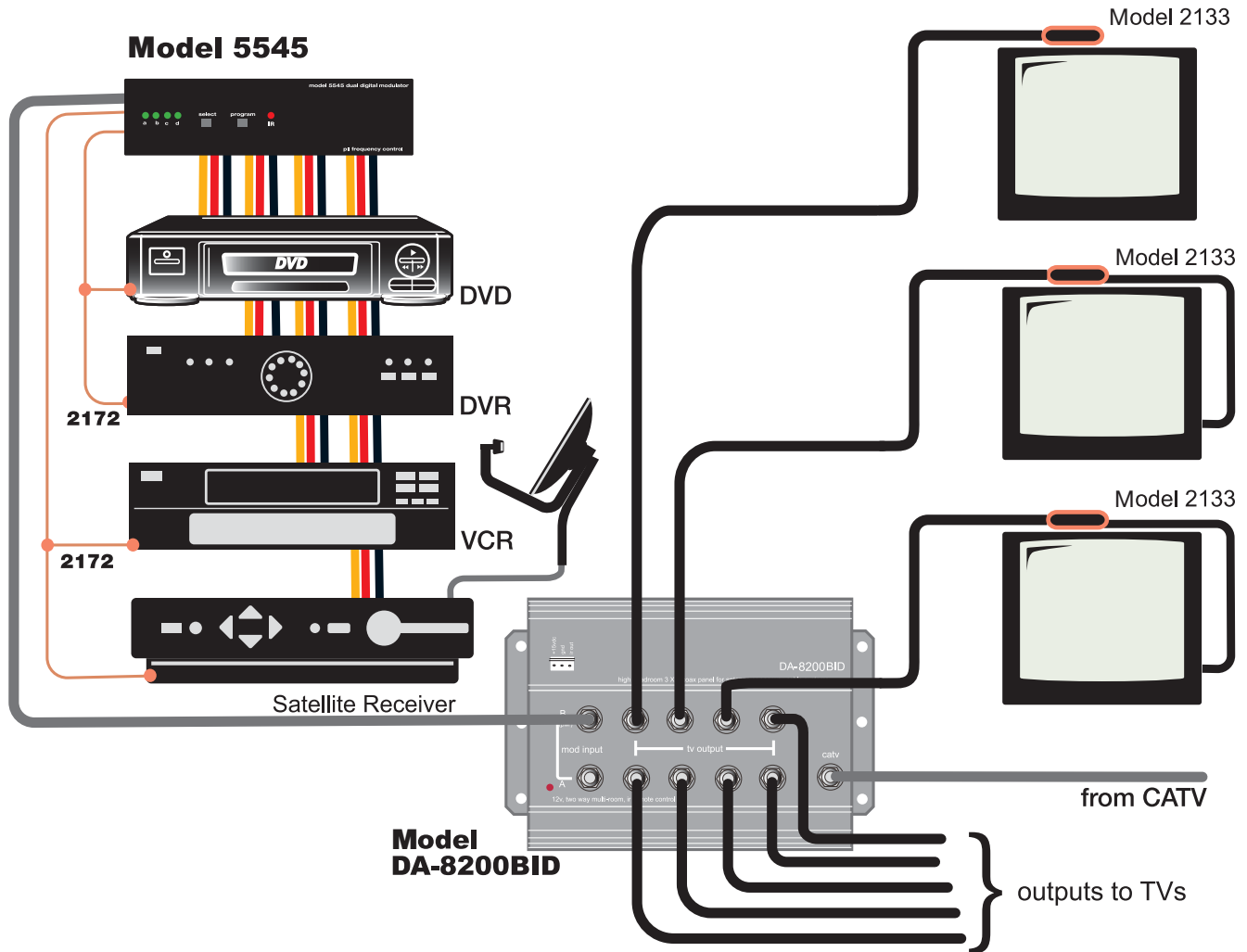

Accessories included with 5558BID:



Two Model 2172 Dual-head IR Emitters



One Model 5545 4-channel Video Modulator with IR



One Model DA-8200BID Bi-directional RF Distribution Amplifier with 5-volt IR



Three Model 2133 5-volt Set-top Targets

Applications for Splitters/Combiners and Taps

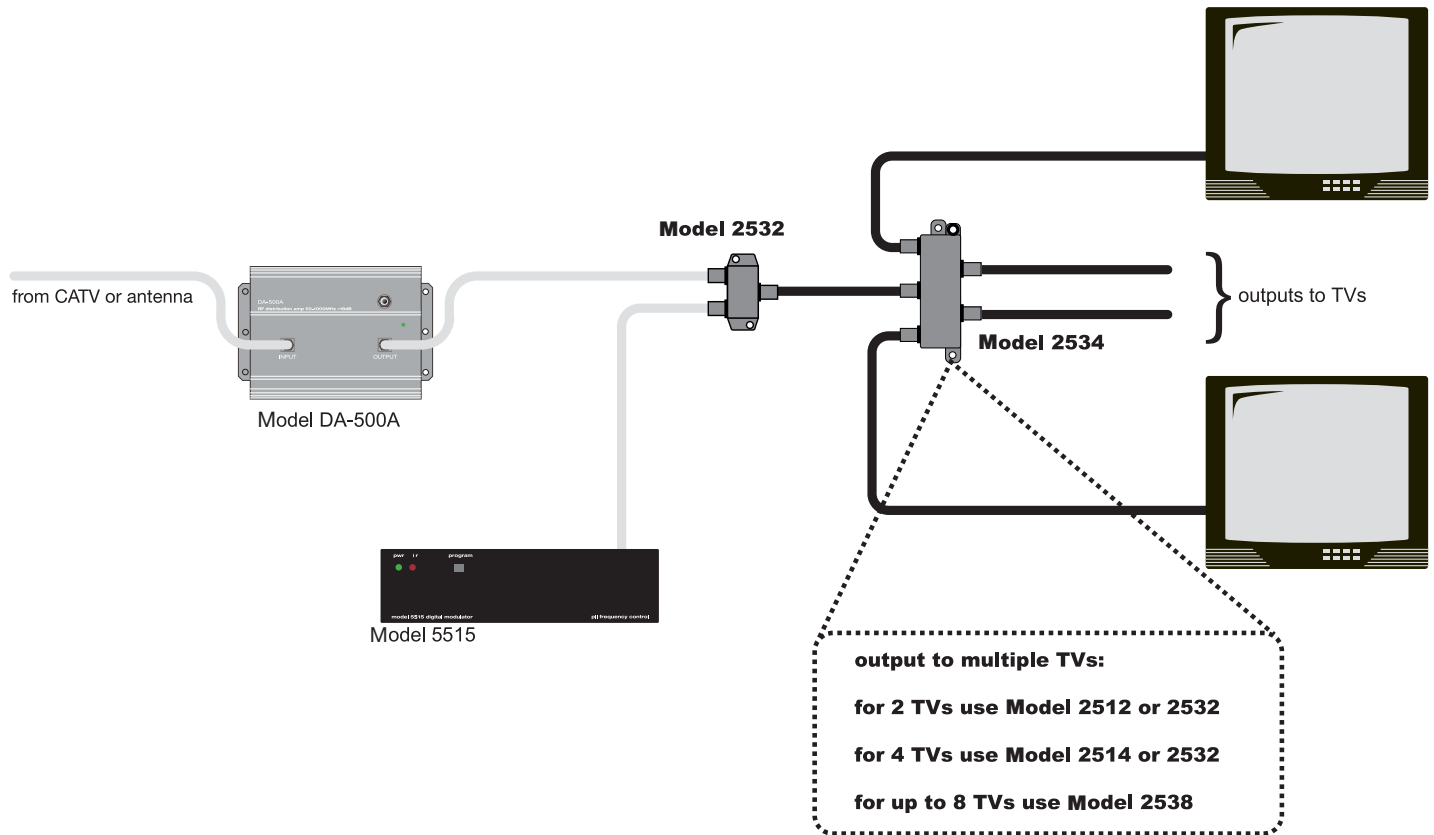

MODEL DC AND IR	AS A SPLITTER	AS A COMBINER	LOSS	INSERTION PASSING
2512			3.5	yes
2532			4.0	no
2514			8.0	yes
2534			9.0	no
2509			through 1.0 tap 9.0	no
2538			12.0	no

72 Application Diagrams



Frequently Asked Questions About DTV-Compatible Amplifiers

Q. Can I use Linear's amplifiers to distribute DTV?

A. Yes, Linear's DA series amplifies all video signals between 54 MHz and 1 GHz. Television, including DTV, is broadcast between 55 MHz and 800 MHz. Our new generation of amplifiers increases headroom to reduce distortion and accommodates digital signals. In addition, they offer more robust power and greater EMI rejection.

Q. When do I use a bi-directional (BID) amplifier and when do I use a high headroom (HHR) amplifier?

A. Either amplifier can be used with DTV. The BID amplifier has a 5-42 MHz return path designed for cable modems and interactive cable boxes (pay-per-view). Use the HHR amplifier for installations where an antenna is being used.

Q. When is Linear going to make a DTV modulator?

A. A modulator is not needed for "off-the-air" DTV. Modulators are only used to distribute local video sources. Currently, there are no video sources that provide the ATSC (DTV) data stream. When DVD players or VCRs that generate HDTV signals become available, we will design a solution to distribute them.

Q. How do NTSC and DTV differ?

A. NTSC and DTV differ in picture format, lines of resolution, modulation methods when transmitted, and audio encoding.

NTSC is an analog RF transmission with a picture format of 4:3. The resolution rate is 525 lines with 480 lines of active interlaced material. Interlaced means that the 480 lines are divided into two fields; even numbered lines are transmitted during field one and odd numbered lines are transmitted during field two. Each field is drawn on the screen every 60th of a second, this is known as 480i. The audio is transmitted using MTS stereo and Dolby Pro Logic®.

DTV or ATSC is a digital video standard and is transmitted using 8VSB modulation. There are 18 variations on the standard, with many having an aspect ratio of 16:9. All DTV tuners are compatible with all 18 standards. The three main standards include 480p, 720p, and 1080i. The 480p and 720p are progressive formats, which allows the entire picture to be drawn in a single pass. The 1080i is interlaced and, like NTSC, is drawn in two passes of two separate fields. Only the 720p and, 1080i displayed in a 16:9 format are considered to be true HDTV. 480p is considered standard television (SDTV). The audio is encoded using Dolby Digital, offering up to 5:1 channels of digital sound.

OFF-AIR BAND	VHF low		VHF high		UHF											
CHANNEL NUMBER	2-6		7-13		14-69											
Linear Amplifiers	← 54 MHz-1 GHz →															
DTV	2-6	7-13		14-69												
FREQUENCY MHz	50	100	150	200	250	300	350	400	450	500	550	600	650	700	750	800
CABLE BAND	VHF low		MID band	VHF high	SUPER band	HYPER band		ULTRA band								
CHANNEL NUMBER	2-6		14-22	7-13	23-36	37-64		65-125								

Troubleshooting with Channel Plus

No Picture

Verify that the video source is on and is producing a video signal. Check that the TV and the modulator are tuned to the same channel. For example, if the modulator is broadcasting on UHF channel 16, make sure the TV is on UHF 16 rather than CATV 16. UHF 16 and CATV 16 are at different frequencies.

Weak Modulated UHF Channel

If the TV has a separate UHF input, be sure that it is connected.

LEDs on the Modulator Blink

The display will blink if you have assigned the same channel to multiple inputs. You need to have one unused channel space between channels.

Diagonal Lines, Known as Herringbone Interference, on Modulated Channels

You may have chosen a channel number that is not completely vacant. Distant UHF stations may be unviewable, but will cause interference if you try to create a new channel at the same frequency. Also, cable companies often have extra signals where there should be none. Move the modulated channel to another number. You may have to add a low-pass filter to remove cable company noise. If a filter does not work, try adding a DC-block to remove common mode interference.

Herringbone Interference on Multiple Channels, Including Modulated Channels

If the problem disappears when you remove the CATV/Ant feed then the RF amplifier is overloaded by abnormally strong signals. Often, you can cure the problem with a simple attenuator. Use a variable attenuator and try to find a signal level where the interference just disappears. Sometimes, the problem is one station that is far stronger than the rest. Attenuating all of the signals with a simple attenuator will cause the desired stations to be weak (snowy). In this case you must reduce the strength of only the offending station. A common FM trap will help if the problem is a nearby FM tower. If the problem is a nearby TV station, often the station management can provide suitable filters.

Audio Volume is Low

The left and right audio inputs are combined for monaural. For proper audio level, both right and left inputs must be used. If you have a mono source, connect it to both right and left inputs using an RCA "Y" connector.

No Color on Modulated Channels

You may have chosen the incorrect cable standard. Not all televisions can accommodate the 1.25 MHz frequency difference between the H and I cable standards.

Trouble with the Infrared Remote Control

Use the red IR DATA light on the modulator as a troubleshooting aid. This light will blink as remote control signals are relayed. If the light is constantly on, one or more of the IR targets is receiving electrical or optical noise. At the distribution unit, begin to disconnect the outputs to the TVs until the IR DATA light goes off. This will tell you which IR target is the source of the noise. Next, cover the front of the offending IR target. If the IR DATA light turns off, the IR target is "seeing" a source of IR noise, such as a solid-state fluorescent lamp. If the light does not go out, the problem may be radiated electrical noise from the plasma or direct-view TV. Reposition this IR target. On 5-volt systems, if repositioning the IR target does not help, the TV may be conducting noise from its input. Place a DC block between the IR target and the TV. If the IR DATA light seems to indicate a proper operation, but the component is not being controlled, the IR emitter may be mislocated. Be sure the emitters are in front of the IR sensor on the video source.

74 Reference Section

System Design

- Layout system, noting lengths of runs, locations of splitters, taps, combiners, and TV sets. Where cable runs exceed 200' (60 m), add a tilt compensator whenever an amplifier stage follows.
- Determine cable type to be used and enter all system losses using the chart below.
- Add amplifiers when necessary to ensure that the signal level never falls below 0 dBmV (60 dBµV) at any point in the system and that TVs get at least 5 dBmV (65 dBµV) of signal.
- Add attenuators when necessary to ensure that the signal level at the TVs does not exceed 15 dBmV (75 dBµV).
- Study the example below. If you need help call Linear Technical Support at 800-421-1587.

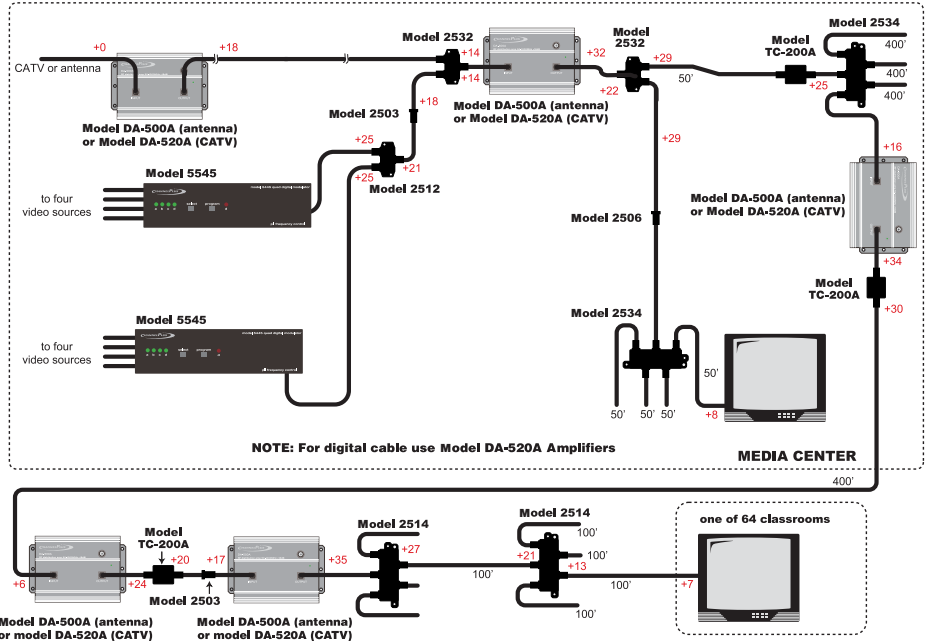

EXAMPLE

68 TV SCHOOL SYSTEM

The head end is located in the media center. A CATV feed is combined with the output of two modulators (typically connected to an assortment of VCRs, satellite receivers, and DVD players). There are four TVs located in the media center and up to 64 TVs located in distant classrooms (up to 650' from the media center). The small numbers in red indicate the signal level in dBmV (add 60 dBmV) at various locations in the system. For the gains and losses associated with the various RF components, see the chart below.

Component Description	Model	Gain	Loss	Your System
Coaxial Cable 75Ω impedance	RG59		7.6 dB/100' (24.9B/100m)	
	RG6		6.0 dB/100' (19.7 dB/100 m)	
	RG11		4.0 dB/100' (13.1 dB/100 m)	
Splitters and Combiners	2512		3.5 dB	
	2532		4.0 dB	
	2514		8.0 dB	
	2534		9.0 dB	
Tap	2509		1.0 dB through 9.0 dB tap	
Tilt Compensator	TC-200A		4.0 dB	
Attenuator	2503		3.0 dB	
	2506		6.0 dB	
RF Amplifier	DA-500		18.0 dB	

Total Gain
Total Loss

Frequency Spectrum

BROADCAST			CABLE TELEVISION				
band	chnl	off-air	chnl	std	hrc	irc	
VHF low			1		72.0036	73.2625	
	2	55.2500	2	55.2500	54.0027	55.2625	
	3	61.2500	3	61.2500	60.0030	61.2625	
	4	67.2500	4	67.2500	66.0033	67.2625	
	5	77.2500	5	77.2500	78.0039	77.2625	
	6	83.2500	6	83.2500	84.0042	83.2625	
FM radio		88.1000	see low-midband channels 95-99				
		107.9000					
VHF high	7	175.2500	7	175.2500	174.0087	175.2625	
	8	181.2500	8	181.2500	180.0090	181.2625	
	9	187.2500	9	187.2500	186.0093	187.2625	
	10	193.2500	10	193.2500	192.0096	193.2625	
	11	199.2500	11	199.2500	198.0099	199.2625	
	12	205.2500	12	205.2500	204.0102	205.2625	
	13	211.2500	13	211.2500	210.0105	211.2625	
midband	14		14	121.2625	120.0060	121.2625	
	15		15	127.2625	126.0063	127.2625	
	16		16	133.2625	132.0066	133.2625	
	17		17	139.2500	138.0069	139.2625	
	18		18	145.2500	144.0072	145.2625	
	19		19	151.2500	150.0075	151.2625	
	20		20	157.2500	156.0078	157.2625	
	21		21	163.2500	162.0081	163.2625	
	22		22	169.2500	168.0084	169.2625	
	superband	23		23	217.2500	216.0108	217.2625
		24		24	223.2500	222.0111	223.2625
25			25	229.2625	228.0114	229.2625	
26			26	235.2625	234.0117	235.2625	
27			27	241.2625	240.0120	241.2625	
28			28	247.2625	246.0123	247.2625	
29			29	253.2625	252.0126	253.2625	
30			30	259.2625	258.0129	259.2625	
31			31	265.2625	264.0132	265.2625	
32			32	271.2625	270.0135	271.2625	
33			33	277.2625	276.0138	277.2625	
34			34	283.2625	282.0141	283.2625	
35			35	289.2625	288.0144	289.2625	
36			36	295.2625	294.0147	295.2625	
hyperband	37		37	301.2625	300.0150	301.2625	
	38		38	307.2625	306.0153	307.2625	
	39		39	313.2625	312.0156	313.2625	
	40		40	319.2625	318.0159	319.2625	
	41		41	325.2625	324.0162	325.2625	
	42		42	331.2625	330.0165	331.2625	
	43		43	337.2625	336.0168	337.2625	
	44		44	343.2625	342.0171	343.2625	
	45		45	349.2625	348.0174	349.2625	
	46		46	355.2625	354.0177	355.2625	
	47		47	361.2625	360.0180	361.2625	
	48		48	367.2625	366.0183	367.2625	
	49		49	373.2625	372.0186	373.2625	
	50		50	379.2625	378.0189	379.2625	
	51		51	385.2625	384.0192	385.2625	
	52		52	391.2625	390.0195	391.2625	
	53		53	397.2625	396.0198	397.2625	
	54		54	403.2500	402.0201	403.2625	
	55		55	409.2500	408.0204	409.2625	
	56		56	415.2500	414.0207	415.2625	
	57		57	421.2500	420.0210	421.2625	
	58		58	427.2500	426.0213	427.2625	
	59		59	433.2500	432.0216	433.2625	
	60		60	439.2500	438.0219	439.2625	
	61		61	445.2500	444.0222	445.2625	
	62		62	451.2500	450.0225	451.2625	
	63		63	457.2500	456.0228	457.2625	
	64		64	463.2500	462.0231	463.2625	

BROADCAST			CABLE TELEVISION				
band	chnl	off-air	chnl	std	hrc	irc	
UHF and ultraband	14	471.2500	65	469.2500	468.0234	469.2625	
	15	477.2500	66	475.2500	474.0237	475.2625	
	16	483.2500	67	481.2500	480.0240	481.2625	
	17	489.2500	68	487.2500	486.0243	487.2625	
	18	495.2500	69	493.2500	492.0246	493.2625	
	19	501.2500	70	499.2500	498.0249	499.2625	
	20	507.2500	71	505.2500	504.0252	505.2625	
	21	513.2500	72	511.2500	510.0255	511.2625	
	22	519.2500	73	517.2500	516.0258	517.2625	
	23	525.2500	74	523.2500	522.0261	523.2625	
	24	531.2500	75	529.2500	528.0264	529.2625	
	25	537.2500	76	535.2500	534.0267	535.2625	
	26	543.2500	77	541.2500	540.0270	541.2625	
	27	549.2500	78	547.2500	546.0273	547.2625	
	28	555.2500	79	553.2500	552.0276	553.2625	
	29	561.2500	80	559.2500	558.0279	559.2625	
	30	567.2500	81	565.2500	564.0282	565.2625	
	31	573.2500	82	571.2500	570.0285	571.2625	
	32	579.2500	83	577.2500	576.0288	577.2625	
	33	585.2500	84	583.2500	582.0291	583.2625	
	34	591.2500	85	589.2500	588.0294	589.2625	
	35	597.2500	86	595.2500	594.0297	595.2625	
	36	603.2500	87	601.2500	600.0300	601.2625	
	37	609.2500	88	607.2500	606.0303	607.2625	
	38	615.2500	89	613.2500	612.0306	613.2625	
	39	621.2500	90	619.2500	618.0309	619.2625	
	40	627.2500	91	625.2500	624.0312	625.2625	
	41	633.2500	92	631.2500	630.0315	631.2625	
	42	639.2500	93	637.2500	636.0318	637.2625	
	43	645.2500	94	643.2500	642.0321	643.2625	
	low-midband			95	91.2500	90.0045	91.2625
				96	97.2500	96.0048	97.2625
				97	103.2500	102.0051	103.2625
				98	109.2750	108.2500	109.2750
			99	115.2750	114.2500	115.2750	
UHF and ultraband continued	44	651.2500	100	649.2500	648.0324	649.2625	
	45	657.2500	101	655.2500	654.0327	655.2625	
	46	663.2500	102	661.2500	660.0330	661.2625	
	47	669.2500	103	667.2500	666.0333	667.2625	
	48	675.2500	104	673.2500	672.0336	673.2625	
	49	681.2500	105	679.2500	678.0339	679.2625	
	50	687.2500	106	685.2500	684.0342	685.2625	
	51	693.2500	107	691.2500	690.0345	691.2625	
	52	699.2500	108	697.2500	696.0348	697.2625	
	53	705.2500	109	703.2500	702.0351	703.2625	
	54	711.2500	110	709.2500	708.0354	709.2625	
	55	717.2500	111	715.2500	714.0357	715.2625	
	56	723.2500	112	721.2500	720.0360	721.2625	
	57	729.2500	113	727.2500	726.0363	727.2625	
	58	735.2500	114	733.2500	732.0366	733.2625	
	59	741.2500	115	739.2500	738.0369	739.2625	
	60	747.2500	116	745.2500	744.0372	745.2625	
	61	753.2500	117	751.2500	750.0375	751.2625	
	62	759.2500	118	757.2500	756.0378	757.2625	
	63	765.2500	119	763.2500	762.0381	763.2625	
	64	771.2500	120	769.2500	768.0384	769.2625	
	65	777.2500	121	775.2500	774.0387	775.2625	
	66	783.2500	122	781.2500	780.0390	781.2625	
	67	789.2500	123	787.2500	786.0393	787.2625	
	68	795.2500	124	793.2500	792.0396	793.2625	
	69	801.2500	125	799.2500	798.0399	799.2625	
	ultraband continued			126	805.2500	804.0402	805.2625
				127	811.2500	810.0405	811.2625
			128	817.2500	816.0408	817.2625	
			129	823.2500	822.0411	823.2625	
			130	829.2500	828.0414	829.2625	
			131	835.2500	834.0417	835.2625	
			132	841.2500	840.0420	841.2625	
			133	847.2500	846.0423	847.2625	
			134	853.2500	852.0426	853.2625	
			135	859.2500	858.0429	859.2625	
			136	865.2500	864.0432	865.2625	
			137	871.2500	870.0435	871.2625	
			138	877.2500	876.0438	877.2625	
			139	883.2500	882.0441	883.2625	
			140	889.2500	888.0444	889.2625	

76 Glossary Of Terms

Adjacent Channels: Two television channels having video carriers 6 MHz apart, or two FM channels having carriers occupying neighboring channel allocations

Amplifier: A device used to increase the power and voltage level of a signal

Attenuator: A passive device used to reduce signal strength

Baseband: A data signal that has not been modulated onto a carrier (e.g., Hi-Fi Audio, NTSC Video, or RS-232 Data)

BID: Bi-directional, as in systems used with CATV services using pay-per-view or cable modems; BID is not for use with off-air antennas

Cable Back-Feed: Signals from an inserted modulated channel that travel back into the cable source. Using a modulator on a cable service provider's system (CATV or MATV) requires a mixing amplifier or filter (NF-469) to prevent the signal from back-feeding into the cable or antenna system.

Category Rated: Twisted pair communications circuits are rated by category, specifications for which are covered under EIA/TIA 568; the higher the category number, the higher the information capacity of the circuit

CATV (Community Antenna Television): An RF distribution system that distributes television broadcast programs, original programs, premium programming, and other services using a network of coaxial cable

Channel: In television, a portion of the RF spectrum, 6 MHz wide, that carries the audio and video carriers of the television signal

CO (Central Office): A reference to the local telephone exchange carrier

Coaxial Cable: A concentric cable consisting of a center conductor, a dielectric, and a shield; coax used for most MATV and CATV work has a characteristic impedance of 75 ohms

Composite Video Signal: The composite video signal including the picture (luminance) signal, the blanking and sync pulses, and the color (chrominance)

Cross Connect: The physical connection between patch panels or punch-down blocks that facilitates connections from systems and feeds to drops

Crosstalk: The unwanted introduction of signals from one channel to another

Decibel: Abbreviation dB; a logarithmic function used to simplify MATV calculations; decibels can be added or subtracted; 0 dB is the standard reference level for all MATV calculations

dBmV: An absolute signal level where 0 dBmV is equal to 1000 μ V across 75 ohms

Egress: A condition often called "signal leakage" in which signals carried by the distribution system radiate into the air

Filter: Filters are used to block out undesired frequencies; there are two types of filters—band pass and rejection; a band pass filter permits only the desired range to pass through, while the rejection filter attenuates an undesired range of frequencies

Gain: A measure of amplification of a device, usually expressed in dB at the highest frequency of operation

Ghosting: A signal interference condition producing positive or negative pictures displaced in time from the desired picture, caused by multi-path signal reception; ghost pictures also result from cable ringing

HDTV (High-Definition Television): A high-resolution, wide-screen common picture format and transmission standard for bringing broadcast television to the home

Head End: The equipment located at the start of a CATV system; the place where the signals are processed and combined prior to distribution

HHR: A high-head-room amplifier used in high-performance off-air antennas or non-bi-directional CATV systems

Ingress: A condition where an unwanted RF signal leaks into a distribution system

Insertion Loss: Also called "feed through loss"; this is the loss that occurs as signals pass through a passive device; insertion loss occurs in all devices that do not amplify the signal

MATV (Master Antenna Television System): A distribution system that is usually contained within a single building and receives its signals from an antenna or CATV system

Modulation: Placing information, audio/video, onto a higher frequency carrier by means of amplitude, frequency, or phase adjustment

Off-Air: Any channel that can be received by a conventional antenna system, including VHF and UHF broadcasts

Patch Cords: The cords interconnecting terminations at the central distribution panel; typically these cords are terminated with modular plugs

RF (Radio Frequency): Generally refers to data modulated over a high-frequency carrier for wireless transmission

RG-6 Cable: A coaxial cable used for broadband video applications; RG-6 has an 18-gauge center conductor, allowing a higher bandwidth than the RG-59 cable, which has a smaller 20-gauge center conductor; RG-6 uses standard "F" connectors for video equipment connections

Signal Strength: The intensity of an RF signal measured in volts (V), millivolts (mV), microvolts (μ V), or dBmV

Signal-to-Noise Ratio (S/N): The ratio of desired signal level to the undesired noise level expressed in dB

Snow: A large quantity of random noise in a television picture that results from a poor CON (earner-to-noise) ratio

TAP: A device inserted into a feeder line that allows a specific amount of signal to be removed from the feeder line and isolates the TAP port from the main through line

Terminator: A resistive device that matches a cable or the unused output of an active or passive system component to its characteristic impedance; proper termination is required to prevent unused portions from causing reflections back down to the line

Tilt: A linearized change in the frequency response of the CATV system, caused primarily by the frequency-dependent cable loss; tilt is quantified by comparing the difference between the level of the highest channel's video carrier and that of the lowest channel

UHF (Ultrahigh Frequency): Off-air television channels 14 to 83

UTP (Unshielded Twisted Pair): Twisted pair cable without either individual or overall shielding

VHF (Very High Frequency): Off-air television channels 2 to 13

100BASE-T: 100 Mbps 802.3/Ethernet over standard unshielded twisted pair cable specification; 100BASE-T supports network configurations over twisted pair transmission systems up to 100 meters in length without the use of a repeater

Training Outline & Types

Technical Services is the group within Linear LLC that administers Continuing Education Unit (CEU) activities, courses, and programs. Technical training ensures the education and meets the goals of the dealers, distributors, and others who sell the Linear LLC branded products.

The technical training manager reviews the policies and procedures and ensures they meet accreditation requirements for CEUs. Linear LLC accredits their training through the National Burglar & Fire Alarm Association (NBFAA) service of the National Training School. The review process for every program occurs every two years at a minimum.

Linear will ensure the training provides adequate resources to support a positive learning environment. Instructors will be available to provide assistance and support to students.

When students meet the requirements for satisfactory completion of the training program, they are issued a certificate that indicates the title of the program, the name of the instructor, and the number of CEUs for the program. Training in Texas will result in an additional form with the instructors' numbers annotated for state requirements.

Linear maintains the records for approximately one year and can reissue certificates if desired. Information collected during training is only for the use of documenting students attending class and is not sold, released, or transferred for any other purposes.

Linear training is provided by qualified personnel with many years of experience in the field and competence in their topic of instruction. They also have knowledge and skill in instructional methods and learning processes. Feedback is encouraged and collected. Instruction is provided with no discrimination, and the trainers are not compensated for any activity other than for classroom instruction.

Linear offers three types of training through learnlinear.com

Type 1: Instructor Lead Training—On-Site Training
We have product trainers and a sales management team who travel the U.S. to provide training at your facility or at a local distributor. This is a more traditional, classroom-style training option.

Linear programs are divided into four phases of courses. Many of Phase 3 and Phase 4 classes are NTS-approved for installers needing Continuing Education Units (CEUs).



Phase 1: Marketing and Investment Strategies—This presents how our products fit into the market segment. It will outline market share and profitability while showing projected future growth and outlook of product segments. It will show how to leverage your investment into our broad product offerings and maximize profitability.

Phase 2: Sales Training—This covers creating the right expectations for your customers. It goes over qualification questions to ask in order to qualify design to meet customer expectations. It also explains features and advantages by product, enabling you to differentiate products in a way your customer will understand.

Phase 3: Design and Installation Training—This is a brief product overview and explanation of installation and rough-in guidelines. The owner's manuals are reviewed (more than just packing material!). Configuration and system testing is illustrated. Instruction is given to show the customer how to use their new products in their home.

Phase 4: Troubleshooting and Advanced Theory—Very specific installation techniques are explained. Navigating troubleshooting guides and EMI and RFI influences are explored. Chronic problem installations and their root causes, as well as steps required that help avoid future call outs, are illustrated.

Type 2: Instructor Lead Training—Computer-Based Training
A product trainer remotely teaches a course using teleconferences and computer software to present the material. Since a live instructor is leading the training, these classes are scheduled.

Linear offers the ability to take most of the on-site training presentations over the Internet, with an instructor leading the training.

Type 3: Self-Paced Training—Computer-Based
This is similar to taking online college classes. From the convenience of either home or office, you can take classes at your own pace and return to previous sessions should you need to stop mid-class.

If you have any questions, feel free to email at techsupport@linearcorp.com or call **1-800-421-1587** and ask for our training manager.

78 Technical Support

Linear's Technical Services Support



Linear's Technical Services Department provides telephone support for our expanding product line. The group supports nearly 1,000 products in various types of installations and applications. Application engineers can assist dealers and installers with their technical questions regarding every Linear product.

The application engineers answer questions regarding equipment installation, programming, system design, troubleshooting, and inter-system compatibility. Questions could be about radio controls, security systems, access controls, door operators, gate operators, audio or video equipment, and accessories. Often, installers simply need fast help with their installation issues so they can complete the job and continue on to the next installation. Linear's quality and professional technical support staff provides that service.

The new extended Technical Services Department telephone service hours (5:00 AM to 4:30 PM Pacific Time) will be of value to nationwide installers and company representatives alike. West Coast callers will be able to call as early as 5:00 AM local time, and East Coast callers will be able to call as late as 7:30 PM local time.

Linear Technical Services provides direct access to the people who know Linear products best. To speak with a Linear expert, call 1-800-421-1587 and press 3.

State-of-the-Art Manufacturing Facility



Sound plans implemented with quality products and solutions to support them are critical to success in today's competitive global business environment. With a state-of-the-art manufacturing facility in China, Linear uses industry-leading manufacturing technologies that enable production of quality products that consistently raise the standard in home technology and provide a value you can depend on in today's competitive marketplace.

High-performance production tools, advanced technologies and techniques in design and testing, integrated circuitry, microchip, and surface mount technology, as well as the latest electronic component assembly and quality assurance techniques are features you can depend on from Linear manufacturing. Linear's Hong Kong manufacturing operation boasts a staff of more than 1,300 and is ISO 9001:2000 quality system certified.

80 Distribution Centers

West & East Distribution Centers



To streamline order fulfillment and shorten delivery time for Linear distributors and dealers, Linear LLC maintains two fully stocked regional distribution facilities in Vista, California, and Summerville, South Carolina.

Linear's Western Distribution Center has 90,000 square feet with 19 shipping docks. Linear's Eastern Distribution Center boasts 175,000 square feet with 25 shipping docks and is the third largest UPS shipper in the Charleston, South Carolina, area.

Both warehouse locations are completely equipped with shipping, receiving, and quality control facilities, and they each stock tens of thousands of Linear products for security, entry systems, communications, audio/video/data, central vacuum systems, and personal emergency response. Each warehouse team receives dozens of cargo containers each month, processes hundreds of orders daily, and ships thousands of packages with Linear goods to worldwide destinations each day.

PRODUCT	ORDER #	PAGE	PRODUCT	ORDER #	PAGE
2010	2010	36	DS3B2	DS3B2	47
2100A	2100A	36	FSHW	FSHW	56
2130A	2130A	36	FSHWB	FSHWB	56
2131	2131	36	H000	H000	42
2132	2132	36	H001	H001	42
2133	2133	36	H008	H008	40
2171	2171	37	H011	H011	40
2172	2172	37	H200	H200	40
2181	2181	37	H205	H205	40
2184	2184	37	H208	H208	42
219558	219558	62	H270	H270	41
226888	226888	62	H271	H271	42
2501-10	2501-10	34	H272	H272	42
2503-10	2503-10	34	H275	H275	41
2506-10	2506-10	35	H281	H281	42
2507-10	2507-10	35	H282	H282	42
2509-10	2509-10	33	H283	H283	42
2512	2512	33	H290	H290	41
2514	2514	33	H291	H291	41
2532	2532	33	H312KIT	H312KIT	38
2534	2534	33	H318	H318	38
2538	2538	33	H336	H336	39
2619	2619	41	H611	H611	26
2620	2620	41	H616	H616	26
2743	2743	62	H618	H618	27
3015	3015	18	H619	H619	27
3025	3025	18	H628	H628	26
350-086	350-086	62	H629	H629	26
350-100	350-100	62	H691	H691	42
350-101	350-101	62	H692	H692	42
350-102	350-102	62	H801	H801	27
350-103	350-103	62	H802	H802	27
5415	5415	19	H803	H803	28
5425	5425	19	H804	H804	28
5435	5435	19	H806	H806	28
5445	5445	19	H808	H808	28
5515	5515	20	H816BID	H816BID	15
5525	5525	20	H838BID	H838BID	17
5545	5545	20	H838HHR	H838HHR	17
5555BID	5555BID	21	HC18A	HC18A	38
5555HHR	5555HHR	21	HC36A	HC36A	39
5557BID	5557BID	22	HD18	HD18	39
5557HHR	5557HHR	22	HD36	HD36	39
5558BID	5558BID	23	HDMI-DA-1X8	HDMI-DA-1X8	9
5558HHR	5558HHR	13	HDMI-DA-2X8M	HDMI-DA-2X8M	10
999-017-01	999-017-01	62	HDMI-MX-4X4	HDMI-MX-4X4	10
C-BACK	C-BACK	35	HDMI-SB	HDMI-SB	12
COMP-2-HDMI-AD	COMP-2-HDMI-AD	35	HDMI-SW-2X2M	HDMI-SW-2X2M	6
COMP-CAT5-EXT	COMP-CAT5-EXT	11	HDMI-SW-2X4M	HDMI-SW-2X4M	6
COMP-DA-1X3	COMP-DA-1X3	8	HDMI-SW-3X1	HDMI-SW-3X1	7
COMP-DA-1X8	COMP-DA-1X8	9	HDMI-SW-4X1	HDMI-SW-4X1	7
DA-500A	DA-500A	15	HDMI-SW-4X2M	HDMI-SW-4X2M	8
DA-506BID	DA-506BID	15	HTWP	HTWP	61
DA-520A	DA-520A	15	HTWP7	HTWP7	61
DA-550BID	DA-550BID	16	IM1	IM1	60
DA-550HHR	DA-550HHR	16	IM1D	IM1D	60
DA-8200BID	DA-8200BID	16	IR-EXTENDER	IR-EXTENDER	12
DA-8200HHR	DA-8200HHR	17	LPF-380	LPF-380	34
DMC-10AWP	DMC-10AWP	31	LPF-470	LPF-470	34
DMC-10DFAB-4	DMC-10DFAB-4	32	LPF-600	LPF-600	34
DMC-10DFBB-4	DMC-10DFBB-4	32	LPF-750	LPF-750	34
DMC-10DFSN-4	DMC-10DFSN-4	32	MB-55	MB-55	31
DMC-10DFW-4	DMC-10DFW-4	32	MB-56	MB-56	41
DMC-10DPW-4	DMC-10DPW-4	32	MCS-1A	MCS-1A	41
DMC-10DS	DMC-10DS	31	MCS-2A	MCS-2A	45
DMC-10H	DMC-10H	30	MDS-6A	MDS-6A	45
DMC-10KIT	DMC-10KIT	29	MDS-6A KIT#1	MDS-6A KIT#1	44
DMC-10PFAB-4	DMC-10PFAB-4	32	MDS-6A KIT#2	MDS-6A KIT#2	44
DMC-10PFBB-4	DMC-10PFBB-4	32	MDS6A-REM	MDS6A-REM	45
DMC-10PFSN-4	DMC-10PFSN-4	32	MDS-LLK	MDS-LLK	45
DMC-10PS	DMC-10PS	31	MDS-PCK	MDS-PCK	45
DMC-10RFA-4	DMC-10RFA-4	32	MNC	MNC	50
DMC-10RFB-4	DMC-10RFB-4	32	MNCC	MNCC	50
DMC-10RFW-4	DMC-10RFW-4	32	MNCS	MNCS	50
DMC-10RS	DMC-10RS	31	MNCX	MNCX	51
DMD-16	DMD-16	25	MNCXB	MNCXB	51
DMT-16	DMT-16	25	MNCXCB	MNCXCB	51
DMT-24	DMT-24	25	MNCXS	MNCXS	52

82 Index

PRODUCT	ORDER #	PAGE
MNCXSB	MNCXSB	52
MNCXSM	MNCXSM	52
MR6C	MR6C	59
MR6W	MR6W	59
MR8C	MR8C	59
MR8W	MR8W	59
NF-469	NF-469	33
NF-470	NF-470	33
NF-471	NF-471	33
PACKHTNS	PACKHTNS	58
PSW108	PSW108	53
PSW112	PSW112	53
ROCK8G	ROCK8G	56
ROCK8R	ROCK8R	56
S100C	S100C	58
S100W	S100W	58
S40C	S40C	57
S50C	S50C	57
S50CKIT	S50CKIT	57
S50W	S50W	57
SCALER-2-1080P	SCALER-2-1080P	13
SL2	SL2	61
SL4	SL4	61
SL1	SL1	60
SVC-10	SVC-10	14
SVC-10R	SVC-10R	14
SVD-8	SVD-8	14
SVM-22	SVM-22	24
SVM-24	SVM-24	24
TC-200A	TC-200A	35
V902	V902	35
WG100C	WG100C	54
WG100W	WG100W	54
WG150C	WG150C	55
WG150W	WG150W	55
WPW-D7.1	WPW-D7.1	61
WPx-DD	WPx-DD	43
WPx-DP	WPx-DP	43
WPx-PC	WPx-PC	43
WPx-PDC	WPx-PDC	43
WS5	WS5	56
XDM4600KIT	XDM4600KIT	46
XDM46EH	XDM46EH	46
XDM46K	XDM46K	47
XDM46KAF	XDM46KAF	48
XDM46KBF	XDM46KBF	48
XDM46R	XDM46R	47
XDMCKIT	XDMCKIT	49
XDMIRE	XDMIRE	49
XDMWP	XDMWP	47

Linear

Audio, Video & Data Solutions

Linear LLC 1950 Camino Vida Roble, Ste.150, Carlsbad, CA 92008 USA
1 800 421 1587 / linearcorp.com

Linear[®]
Building On Innovation.

Copyright 2008, Linear LLC P/N 228655A Printed in China