

Fiber Optic System
Four-Channel Video and Multi-Protocol Data
Models S734DV and S7734DV

installation instructions



GENERAL

This manual is a guide to the installation and operation of the S734DV and S7734DV series fiber optic video and multi-protocol data (MPD) transmission system. Please read the entire manual before installing the equipment.

NOTE: The series numbers S734DV, S734DVT and S734DVR are used to describe all models of transmitters and receivers unless noted otherwise.

The Series S734DV and S7734DV video and MPD transmission system offers simultaneous transmission of four channels of digital video and plus duplex digital control data. It also offers four one-way channels of contact closure/relay transmission.

The S734DV system operates over one multimode fiber while the S7734DV uses one single-mode fiber.

A complete system consists of an S734DVT transmitter and an S734DVR receiver. Units are designed for standalone operation or for installation in Fiber Options' 515R1 or 517R1 Card Cages or 502R standalone enclosures.

Unpacking the Unit

In the event that anything is missing from the following list, contact your authorized Fiber Options dealer or representative.

S734DVT Transmitter or S734DVR Receiver
(S7734DVT Transmitter or S7734DVR Receiver)

Instruction manual

Save the original packing materials in case it becomes necessary to return the unit.

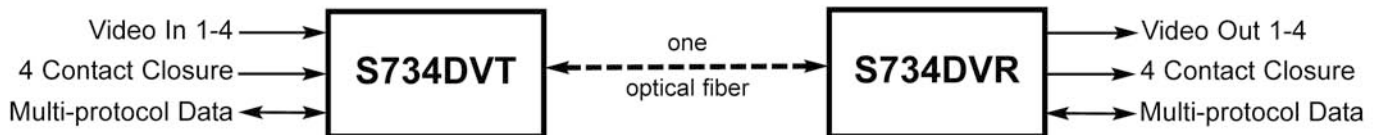
SYSTEM DIAGRAM**INSTALLATION****Installation Considerations**

This fiber-optic link is supplied as a standalone module or as a rack card. Units should be installed in dry locations protected from extremes of temperature and humidity.

Standalone Modules

1. Determine where the module will be installed, and ensure that there is adequate space at both ends for making the various cable connections.

2. Standalone modules feature a wall-mounting plate which is attached to suitable flat surfaces with six No. 6 (3-mm or 3.5-mm) screws. Once the plate is securely attached to a flat surface, the S734DV is mounted on the plate and can be easily removed. Refer to Figure 1 for details.

3. An additional, optional bracket is also provided for more secure mounting. The type of screws must be suitable for the surface where a module will be mounted. Refer to Figure 2.

FIGURE 1: MOUNTING PLATE

Mounting plate attaches to selected surface with four suitable screws. Standalone modules are mounted by sliding it onto the plate's hooks until firmly seated. The module can be easily removed and remounted.

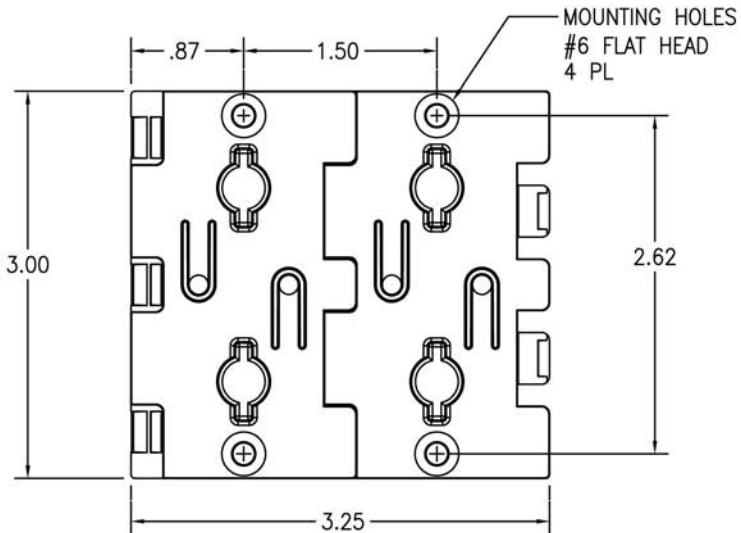

Rack Cards

Rack cards are designed to be installed in one of Fiber Options' 19-inch (483-mm) EIA standard card-cage racks, either the 515R1 or the 517R1. They may also be supplied in the 502R standalone rack card enclosures. Follow these steps after performing MODULE SETUP procedures.

515R1 and 517R1 Card Cage Racks

CAUTION: Although rack cards are hot-swappable and may be installed without turning off power to the rack, Fiber Options recommends that the power switch on the rack power supply be turned OFF and that the rack power supply is disconnected from any power source.

1. Make sure that the card is oriented right-side up, and slide it into the card guides in the rack until the edge connector at the back of the card seats in the corresponding slot in the rack's connector panel. Seating may require thumb pressure on the top and bottom of the card's front panel.

CAUTION: Take care not to press on any of the LEDs.

2. Tighten the two thumb screws on the card until the front panel of the card is seated against the front of the rack.

502R Standalone Enclosures

CAUTION: Although rack cards are hot-swappable and may be installed without turning off power to the rack, Fiber Options recommends that the power switch on the rack power supply be turned OFF and that the rack power supply is disconnected from any power source.

1. Look inside the enclosure to determine the location of the socket for the edge connector. Orient the card so that it will seat in the socket, and slide it into the enclosure until the edge connector at the back of the card seats in the socket. Seating may require thumb pressure on the top and bottom of the card's front panel.

CAUTION: Take care not to press on any of the LEDs.

2. Tighten the two thumb screws on the card until the front panel of the card is seated against the front of the rack.

MODULE SETUP

General

Determine the data formats required for input and output. The input and output formats may be the same or different, as described in the next section.

Data Selection

NOTE: The DATA SELECT switch on standalone units, or SW1 on rack cards, is shipped in the Disabled setting.

Using the rotary DATA SELECT switch, select a valid data format according to the DATA SELECT settings shown in Figure 3. See Figures 4 through 6 for the location of the DATA SELECT switch.

NOTE: If the link is going to support RS-485, refer to RS-485 APPLICATION NOTES on page 10.

FIGURE 3: DATA SELECT SWITCH SETTINGS

Setting	Mode	Setting	Mode
0	Disable (factory preset)	8	RS-485 2-wire 2V
1	RS-232	9	RS-485 4-wire standard
2	RS-232 + handshake	A	RS-485 4-wire 1V
3	TTL	B	RS-485 4-wire 2V
4	RS-422 2-wire	C	Reserved
5	Manchester/Biphase	D	Reserved
6	RS-485 2-wire standard	E	Reserved
7	RS-485 2-wire 1V	F	Test Mode Tx

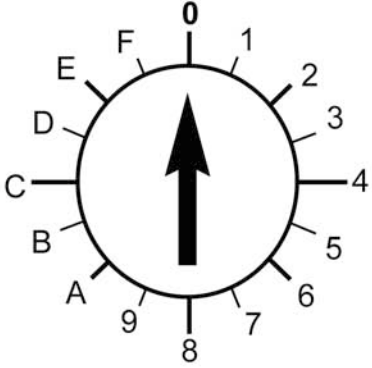

FIGURE 4: RACK-MOUNT RECEIVER - SWITCH AND JUMPER LOCATION

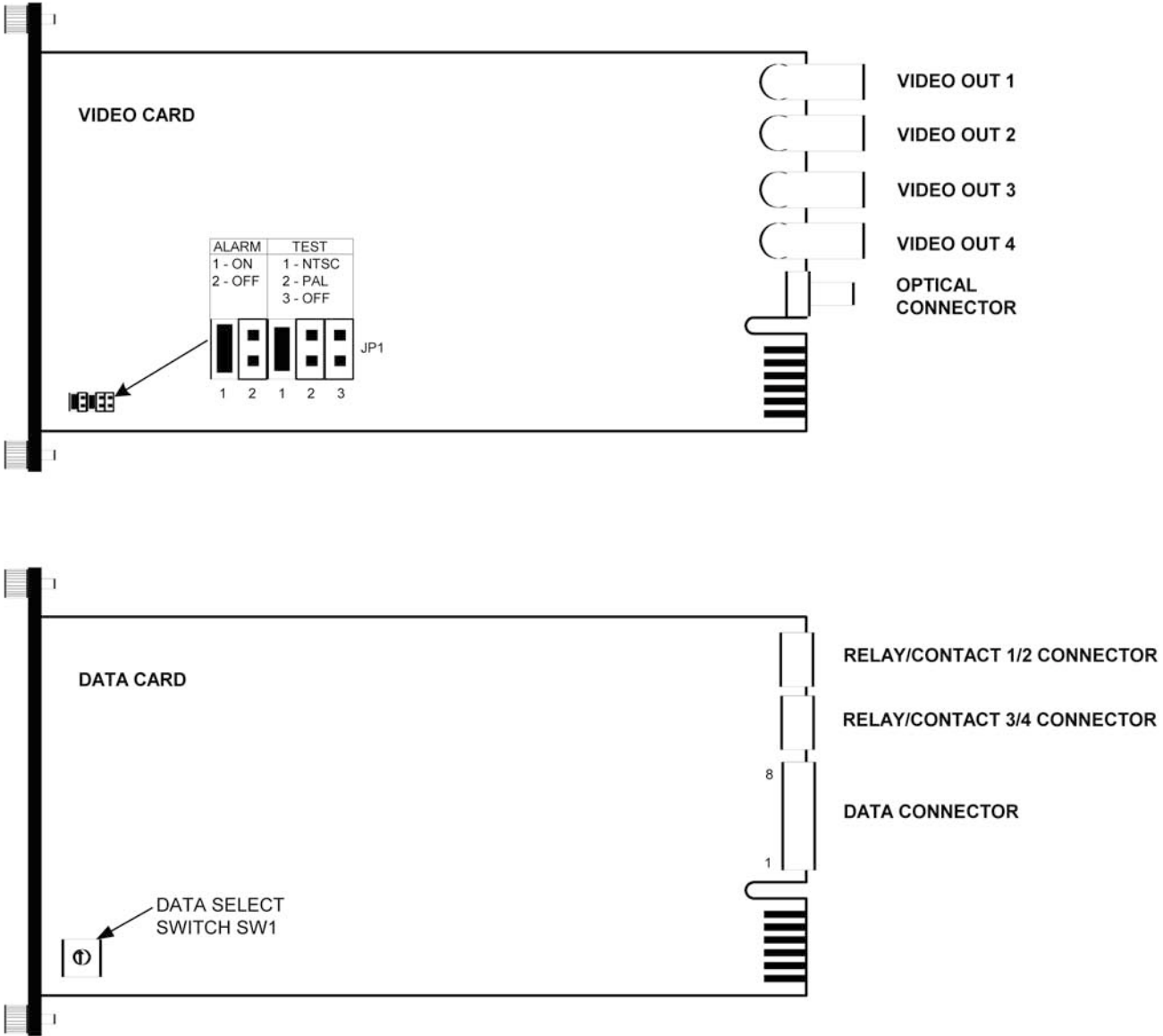
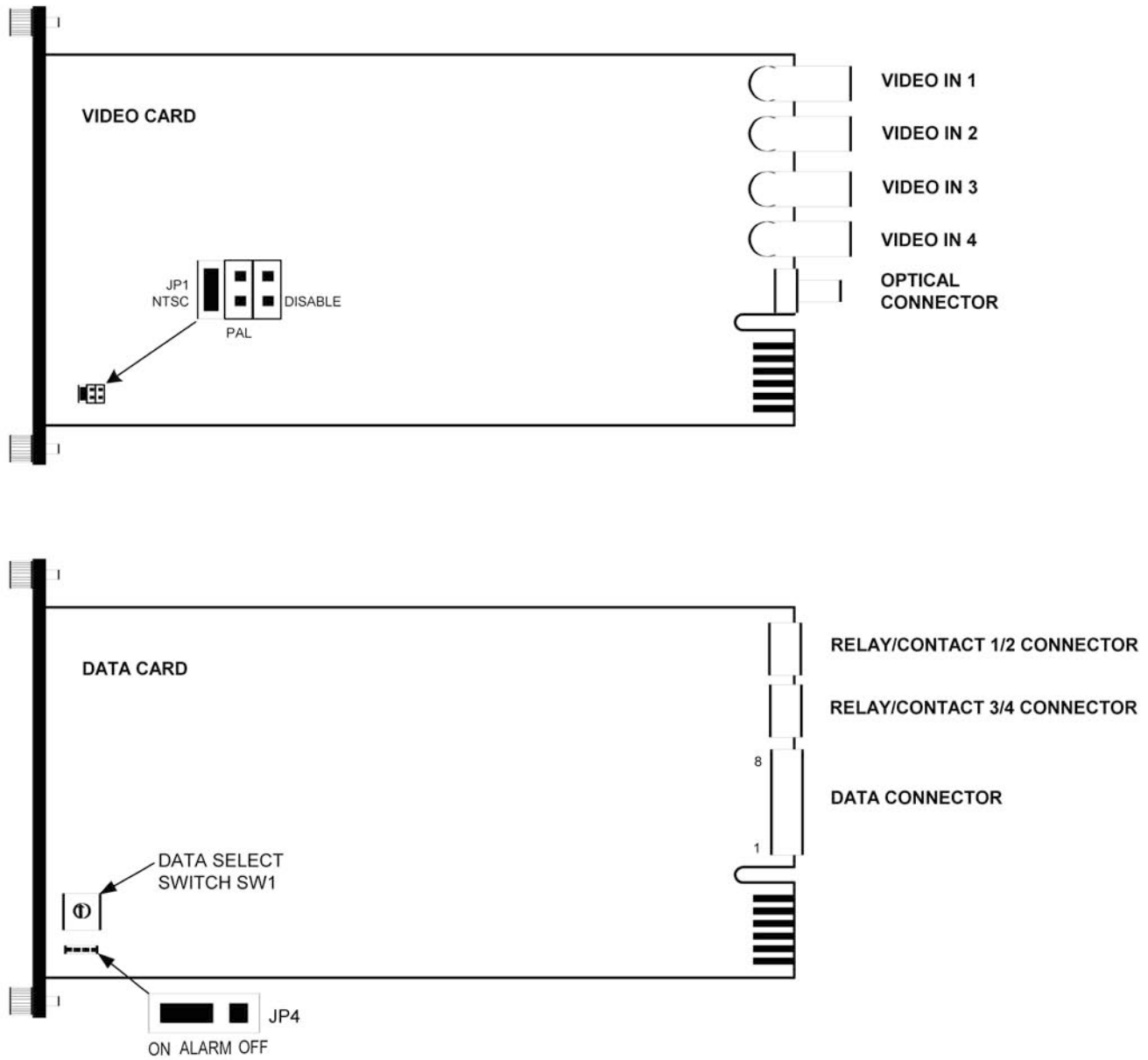

FIGURE 5: RACK-MOUNT TRANSMITTER - SWITCH AND JUMPER LOCATIONS



Alarm Jumper

Rack cards are supplied with an alarm function that activates if the optical signal input to the receiver fails. The alarm is always indicated on the front panel of the card by a red LEVEL/LOSS™ LED. The alarm may also be output to the rack power supply, where a sonalert (audible alarm) and alarm output contact closure may be activated.

The alarm is set to ON (ACTIVE) at the factory. If the alarm output is not desired, move jumper JP1 on the receiver or JP4 on the transmitter to the OFF position. Refer to Figures 4 and 5.

NOTE: Setting alarm to OFF (inactive) does not affect the operation of the LEVEL/LOSS™ LED. Loss of optical signal will always be indicated by a red LEVEL/LOSS™ LED.

FIGURE 6: STANDALONE TRANSMITTER/RECEIVER

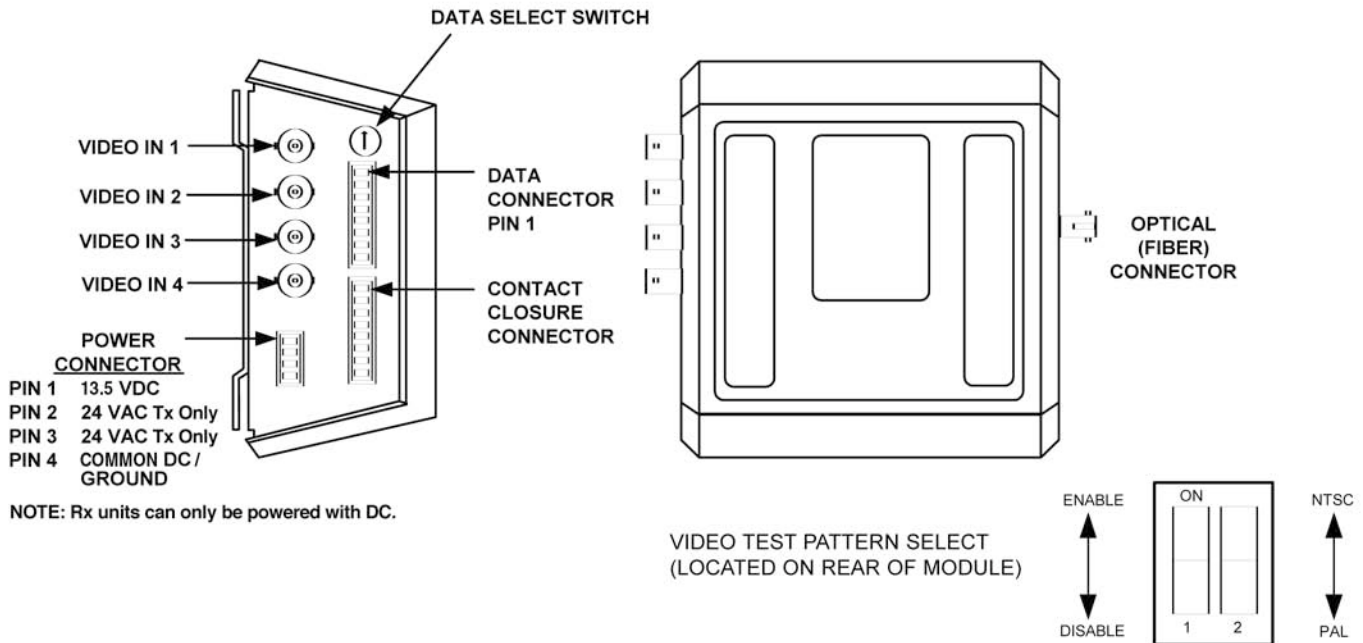

NOTE: Rx units can only be powered with DC.

Video Format/Test Pattern Generator

The S734DV links support both NTSC and PAL video standards without adjustment. The S734DVT transmitter and S734DVR receiver have jumpers or a switch to select the video format for the test pattern generator. To set the video format for the test pattern generator:

NOTE: In order for the test pattern generator to operate properly, both the transmitter and receiver must be set to the same format.

1. Set jumper JP1 on the receiver board to position 1 for NTSC, position 2 for PAL, or position 3 to disable the test pattern generator. See Figure 4.
2. (Rack-mount transmitter only) Set jumper JP1 on the transmitter to the NTSC, PAL, or disabled position as required. See Figure 5.
3. (Standalone units only) Switch S1, located through mounting hole on back of unit, configures the test pattern generator. Position 1 enables test patterns when in the ON position. S1 position 2 selects video standard; ON selects NTSC, while OFF selects PAL. See Figure 6.

Disabling the test pattern generator causes no signal output during the failure conditions or when using the Test Mode described on page 9.

Data Translation

The data translation capability of the S734DV series is unique in the industry. It allows translation from one format to another, thus eliminating the need for external translation devices. Data translation examples are shown in Table 1.

The translation is in the physical layer only; it cannot interpret specific protocols, nor translate commands. Due to the encoding schemes utilized in Manchester and Biphase, these formats are exempt from translation.

CONNECTIONS

Data Connections

Data connections are made to the removable screw terminal on the S734DV according to the selected format. Refer to Tables 2 through 10 for transmitters and receivers. When connecting data cables, always wire the DATA OUT pins on the data equipment to the DATA IN pins on the fiber links, and the DATA IN pins on the data equipment to the DATA OUT pins on the fiber links. See Figure 7. See Figure 6 for the standalone transmitter and Figure 8 for rack cards.

TABLE 1: DATA TRANSLATIONS

Translation	TX Switch Setting	RX Switch Setting	Comment
TTL → RS-232, 3 wire	3	1	Signal level conversion.
RS-232, 3 wire → TTL	1	3	Signal level conversion.
TTL → RS-422	3	4	Single Ended to Differential Conversion.
RS-422 → TTL	4	3	Differential to Single Ended Conversion.
RS-232, 3 wire → RS-422	1	4	Single Ended to Differential Conversion.
RS-422 → RS-232, 3 wire	4	1	Differential to Single Ended Conversion.
RS-232, 5 wire → RS-485	2	7 - A	RS-232 Handshaking bit is used to indicate tri-state.
RS-485 → RS-232, 5 wire	7 - A	2	Tri-State detection circuitry activates handshaking bit

FIGURE 7: FIBER LINK DATA CONNECTIONS

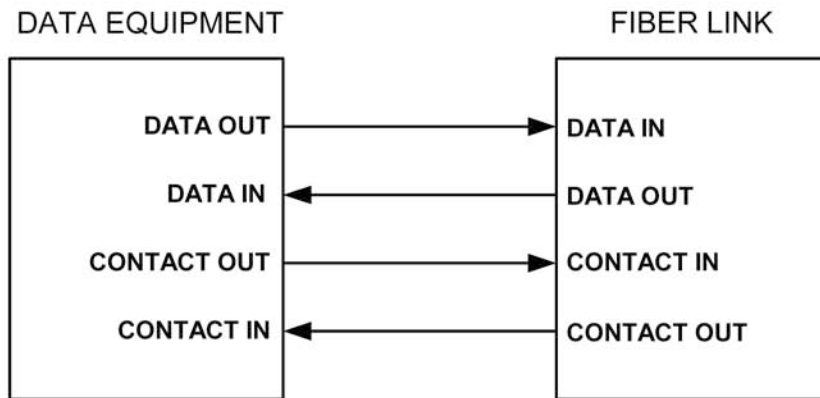
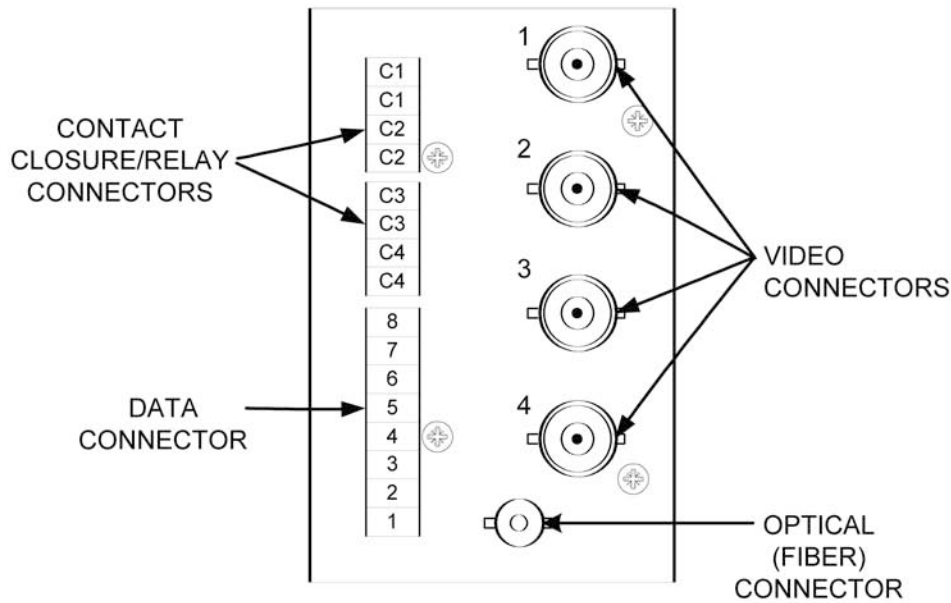

FIGURE 8: REAR CONNECTOR PANEL - RACK-MOUNT CARDS



**TABLE 2:
RS-232 Interface**

Mode Switch SW1: Position 1

Pin No.	Function
8	Ground
7	nc
6	nc
5	RS-232 IN
4	nc
3	nc
2	RS-232 OUT
1	Ground/Shield

**TABLE3:
RS-232 with Handshaking Interface**

Mode Switch SW1: Position 2

Pin No.	Function
8	Ground
7	nc
6	RTS/CTS IN
5	RS-232 IN
4	nc
3	RTS/CTS OUT
2	RS-232 OUT
1	Ground/Shield

**TABLE 4:
TTL Interface**

Mode Switch SW1: Position 3

Pin No.	Function
8	Ground
7	nc
6	TTL IN
5	tie to pin 1
4	nc
3	TTL OUT
2	nc
1	Ground/Shield

**TABLE 5:
RS-422 Interface**

Mode Switch SW1: Position 4

Pin No.	Function
8	Ground
7	nc
6	RS-422 IN +
5	RS-422 IN -
4	nc
3	RS-422 OUT +
2	RS-422 OUT -
1	Ground/Shield

**TABLE 6:
Manchester/Biphase Interface**

Mode Switch SW1: Position 5

Pin No.	Function
8	Ground
7	nc
6	Manchester/Biphase in +
5	Manchester/Biphase in -
4	nc
3	nc
2	Manchester/Biphase out +
1	Manchester/Biphase out -

**TABLE 7:
Manchester/Biphase Interface
Termination Unit**

Mode Switch SW1: Position 5

Pin No.	Function
8	Ground
7	Manchester/Biphase termination; tie to pin 5
6	Manchester/Biphase in +
5	Manchester/Biphase in -
4	nc
3	nc
2	Manchester/Biphase out +
1	Manchester/Biphase out -

**TABLE 8:
RS-485 2-Wire Interface**

Mode Switch SW1:

Position 6 = standard offset

Position 7 = 1V offset

Position 8 = 2V offset

Pin No.	Function
8	Ground
7	RS-485 termination - tie to pin 5
6	RS-485+
5	RS-485 -
4	+5 VDC BIAS OUT
3	nc
2	nc
1	Ground/Shield

**TABLE 9:
RS-485 4-Wire Interface**

Mode Switch SW1:

Position 9 = standard offset

Position A = 1V offset

Position B = 2V offset

Pin No.	Function
8	Ground
7	RS-485 termination - tie to pin 5
6	RS-485 in +
5	RS-485 in -
4	+5 VDC BIAS OUT
3	RS-485 out +
2	RS-485 out -
1	Ground/Shield

**TABLE 10:
Test Mode Loopback Interface**

Mode Switch SW1: Position F

Pin No.	Function
8	Ground
7	nc
6	tie to pin 3
5	tie to pin 2
4	nc
3	tie to pin 6
2	tie to pin 5
1	nc

nc = no connection

Built-In Termination

The S734DV features a built-in termination for RS-485, Manchester and Biphase installations. Simply connect a jumper as described in Tables 7 through 9.

Contact Closure Connections

There are four contact closure channels on this unit. Connecting external equipment to these channels is done using the removable screw terminal connectors on the module. Refer to Figure 6 and 8.

Each channel is indicated by a pair of terminal positions, for example, the two terminals labeled C1. Connect the two wires for the channel 1 relay/contact closure to these two pins. Repeat for channels 2, 3, and 4, using terminal pairs C2, C3, and C4, respectively.

Video Cable Connection

CAUTION: Make sure all peripheral equipment to be connected to the fiber units is turned OFF during installation.

NOTE: Fiber Options suggests that Belden number 9259 or equivalent coaxial cable should be used. Consult the cable manufacturer's specifications for the maximum distance between the video equipment and the fiber equipment.

NOTE: Coaxial cable must be terminated with female BNC connectors to properly couple with the Fiber Options equipment.

1. Connect the four video sources, such as cameras, to the input BNC connectors on the S734DVT transmitter using terminated coaxial cable. See Figures 6 and 8.
2. Connect the monitoring equipment to the output BNC connectors on the S734DVR receiver using terminated coaxial cable. See Figures 6 and 8.

Fiber Optic Cable Connection

Most cable manufacturers identify the individual fibers in the cable. Select appropriately terminated fiber and mark both ends with unique identification label (e.g. for cable no. 03, fiber no. 08) to ensure that the fiber connected to the near end is the same one that is connected to the far end.

The proper optical connection will link the transmitter's TRANSMIT (OUT) port to the receiver's RECEIVE (IN) port. See Figures 6 and 8.

1. Wipe the inside of the port's sleeve with a lint-free pipe cleaner moistened with reagent-grade isopropyl alcohol. Blow dry with dry air.
2. Clean the connector using a lint-free cloth dampened with alcohol to thoroughly wipe the side and end of the ferrule. Blow the ferrule dry with dry air. Visually inspect the ferrule for lint.
3. Fasten the fiber optic cable to the port.

Power Connections

Standalone Modules

Standalone transmitters may be powered either by 24 VAC or by 13.5 VDC. Receiver units are DC only.

Connect input power according to the label on the module. See Figure 6.

Rack Modules

Power connections are made automatically when the card is installed. To supply power to the rack, connect the rack power supply to an AC outlet and set the power switch to ON.

502R Enclosures

Rack cards installed in the 502R enclosure can only be powered by 13.5 VDC. Connect input power according to the label on the enclosure.

SMARTS™ DIAGNOSTICS

The S734DV has built in Status Monitoring And Reliability Test System (*SMARTS™*) diagnostic capabilities. This includes LED indicators for monitoring data and optical status as well as video and data generators for verifying unit functionality. They are described in the following sections.

Video Test Patterns

The S734DV includes an internal video test pattern generator that can ease installation and troubleshooting. Refer to Table 11. The test patterns generated can notify the user of a fiber failure or a video source failure by outputting specific test patterns on the user's monitor.

NOTE: To provide earth ground reference, Stand Alone (Enclosure) modules need to be connected to a good earth ground. This can be accomplished by connecting a copper-based conductor from the modules *DC Common/Ground* pin to an approved earth ground.

If test patterns are enabled a grey screen with two white vertical bars will be output. If test patterns are disabled the screen will be black.

VIDEO IN (or OUT) Indicator

This LED indicates the presence of a video signal. VIDEO IN on the transmitter remains green as long as an adequate video signal is being input to the transmitter.

The LED will be red when no video signal is present. The VIDEO OUT LED on the receiver performs a similar function, except that it refers to the video that is output from the receiver. If test patterns are enabled a grey screen with a single white vertical bar pattern will be output when no video is present. If disabled, the screen will be black.

NOTE: The S734DV monitors the video sync signals to determine the presence of the signal. It does not monitor the picture brightness signal. Thus, if the scene in front of a camera is totally dark, producing a blank monitor screen, the VIDEO LEDs will still be green.

DATA IN Indicator

The DATA IN LED indicates the state of the data being input to the S734DV over copper. A green DATA IN LED indicates a logic HIGH is present on the copper inputs. A yellow DATA IN LED indicates a logic LOW is present on the copper. No color (OFF) indicates a tri-state or high impedance input.

Therefore, this can be used to determine the resting state of your equipment. Unique to the industry, the S734DV has special circuitry to capture data transitions and make them visible on the LEDs. High-speed bursts of activity, previously undetectable by standard LED circuits, can easily be seen by this special circuitry.

DATA OUT Indicator

The DATA OUT LED functions identically to the DATA IN LED except that the LED represents data that is being output from the unit. This LED has the same high-speed capture circuitry described in the DATA IN section.

CONTACT Indicator

The CONTACT LED indicates the presence of relay/contact closure signals. A green CONTACT LED indicates a closed relay contact, while a red LED indicates an open relay/contact.

ENABLED Indicator

This LED has three states; green indicates a valid mode has been selected, red indicates an invalid mode (spare or test mode) has been selected, or flashing red/green indicates that

NO mode has been selected.

RS-485 APPLICATION NOTES

The S734DV is configurable for both full-duplex (4-wire) and half-duplex (2-wire) operation. It can be used for interfacing to systems adhering strictly to the RS-485 specification and for use with systems that use a modified, "fail-safe biased" RS-485 bus.

Connection

Use high quality twisted-pair wiring, and make sure all connection points are clean and tight. A loose connection on one of the wires can appear to function, yet cause intermittent errors: data LEDs may be flashing as signals pass through the system, but those signals will be corrupt.

Configuration

Fiber Options Universal Data units are designed to work with virtually any RS-485 system. Unfortunately, some systems operate on a "modified" version of RS-485; they use failsafe biasing to pull up/down their bus during a tri-state condition. In a standard RS-485 system, when a driver on a properly terminated bus goes into tri-state (inactive), the voltage between the differential outputs should be less than 200 millivolts. (This is considered "standard offset" in the product instruction manuals). A differential output tri-state voltage this small can cause some nonstandard systems to latch up, since they are designed for much larger, "fail-safe," offsets.

To be able to interface to such equipment, Fiber Options Universal Data products offer two more "offset" level modes. That is, the maximum differential input voltage that can be applied where it will be perceived to be in tri-state.

Of course, the equipment manufacturer does not disclose this information. In most cases, the Fiber Options unit should be configured for "standard offset" operation. When the system is operating properly, the DATA IN and DATA OUT LEDs will be off when there is no communication (tri-state) and they will flash when data is being sent or received. In the case where the link is not functioning properly, (LEDs will most likely not turn off), change the DATA SELECT switch on the unit to a higher offset mode. First try 1 V, then 2 V. If simply switching the mode switch does not prove effective, the offset level may have to be emulated at one end of the system by using pull-up/down resistors on the data connector. The S734DV has a +5 V bias pin and ground pins on the connector for this purpose. Contact equipment manufacturer's technical support for recommended resistor values and configuration.

FIGURE 10: FRONT PANELS

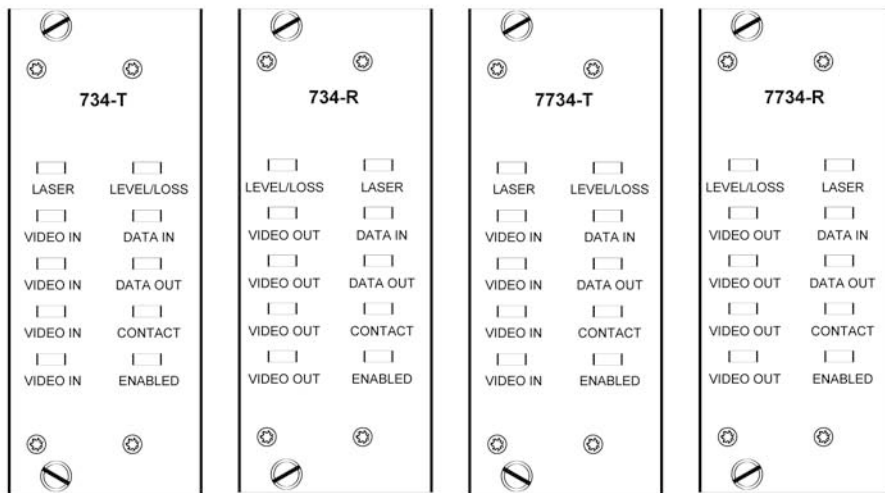

Termination

RS-485 systems need to be properly terminated in order to work reliably. Exactly two terminating resistors are used on each RS-485 bus, at the furthest ends of the link. These resistors should be attached on the DATA IN/OUT connector if the Fiber Options link is at one end of the bus.

If the terminating resistors are left out, the tri-state condition will not be detected, and the bus may lock up. If there are too many terminations on the bus, signal levels may drop too low, or driver circuitry may fail. The standard value of terminating resistors for RS-485 is 120 ohms.

OPERATION

S734DV links operate automatically once installed. Refer to TEST MODE on page 9 for information on how to execute the test mode. Refer to Table 11 for a description of on-screen diagnostic indications. For an explanation of LED color codes, refer to LED OPERATION on page 9 and Table 12.

MAINTENANCE

There is no operator maintenance other than keeping the units clean.

CONTACTING GE SECURITY

If you cannot determine the cause of your problem and are in the U.S. or Canada, call toll-free: 888-437-3287

If you are outside the U.S. or Canada, call the closest international office listed on the back page of this manual. Have the following information available: exact model number and product code of your fiber-optic links, and a listing of the diagnostic indicators and their respective color/condition.

SHIPPING AND PACKAGING

Before shipping or transporting your unit, pack it securely to prevent damage that could occur in transit. Use care to protect all connectors, LEDs, and corners from possible damage.

RETURNS TO GE SECURITY

If any equipment must be returned to GE Security for repair or replacement, you must obtain authorization from our Return Authorization department before shipping.

If you are in the U.S. or Canada, call our headquarters at toll-free: 888-437-3287

Customers in other countries should contact their regional representative listed on the back cover of this manual. A Return Authorizations representative will provide full instructions for returning your product at that time.

NOTE: All authorized returns must be clearly marked with the Return Authorization information. Please follow the instructions completely.

NOTE: GE Security will not accept return delivery of any product without prior authorization.

TABLE 12: LED DIAGNOSTIC INDICATORS

LED Name	Color	Indicates/Corrective Action
LEVEL/ LOSS	Green	Sufficient optical power received. <i>No action required.</i>
	Red	Insufficient optical power received. <i>Verify fiber connected & within optical budget, receiver power on.</i>
LASER	Green	Laser is operating normally. <i>No action required.</i>
	Red	Laser is malfunctioning. <i>Contact Fiber Options.</i>
VIDEO IN/OUT	Green	Valid video signal at unit. <i>No action required.</i>
	Red	No video signal at unit. <i>Verify video connected, video source has power and is transmitting.</i>
DATA IN	Green	Logic high into unit. <i>No action required.</i>
	Yellow	Logic low into unit. <i>No action required.</i>
	off	Tri-state or disabled condition. <i>Verify data connected, data source has power.</i>
DATA OUT	Green	Logic high received over fiber. <i>No action required.</i>
	Yellow	Logic low received over the fiber. <i>No action required.</i>
	Off	Tri-state received over fiber or disabled condition. <i>No action required.</i>
CONTACT	Green	Closed contact sensed on transmitter, or output from receiver.
	Red	Open contact sensed on transmitter, or output from receiver.
ENABLED	Green	DATA SELECT switch set to valid mode. <i>No action required.</i>
	Red	DATA SELECT switch set to Test mode or invalid data format. <i>Check Data Select switch conforms to desired configuration – may be valid.</i>
	Flashing Red/Green	DATA SELECT switch in disabled position (position 0). <i>Select a valid data format.</i>

Customer Support

For assistance in installing, operating, maintaining, and troubleshooting this product, refer to this document and any other documentation provided. If you still have questions, please contact technical support during normal business hours (Monday through Friday, excluding holidays, between 6 a.m. and 5 p.m. Pacific Time).

GE Security

Call: 888 437-3287 (US, including Alaska and Hawaii; Puerto Rico; Canada)

Outside the toll-free area: 503 885-5700

Fax: 561 998-6224

www.gesecurity.com



GE Security

www.GESecurity.com

U.S.

T (561) 998-6100

T 888-GE-SECURITY

888 (437-3287)

F 561 998-6224

E gesecuritycustserv@ge.com

Asia

T 852-2907-8108

F 852-2142-5063

Australia

T 613-9239-1200

F 613-9239-1299

Canada

T 519-376-2430

F 519-376-7258

Europe

T 44-113-238-1668

F 44-113-253-8121

Latin America

T 305-593-4301

F 305-593-4300