

Fiber Optic Transmission System
Models S768DAV and S7768DAV

installation instructions



TABLE OF CONTENTS

BEFORE YOU BEGIN	6
1 INTRODUCTION	7
2 MODULE SETUP	8
2.1 UNPACKING THE UNIT	8
2.2 DATA TRANSLATION	8
2.3 INPUT/OUTPUT DATA FORMAT	8
2.3.1 MANUAL DATA SELECTION	9
2.3.2 AUTO DATA CONFIGURATION	10
2.4 OPTICAL/VIDEO ALARMS	10
2.5 VIDEO FORMAT/TEST PATTERN GENERATOR	11
2.6 AUDIO LEVEL	11
2.7 INPUT IMPEDANCE	12
3 INSTALLATION	13
3.1 RACK CARDS	13
3.2 502R RACK CARD ENCLOSURES	13
3.3 CONNECTIONS	14
3.3.1 BACK PANEL CONNECTIONS	15
3.3.2 INTERFACE BOARD CONNECTIONS	16
3.3.3 BUILT-IN TERMINATION	19
3.3.4 VIDEO CABLE CONNECTIONS	20
3.3.5 AUDIO CONNECTIONS	20
3.3.6 FIBER OPTIC CABLE CONNECTIONS	20
3.3.7 STANDALONE MODULE POWER CONNECTIONS	21
3.3.8 RACK MODULE POWER CONNECTIONS	21
4 OPERATION	22
4.1 NORMAL OPERATION	22
4.2 LED OPERATION	22
4.2.1 LASER INDICATOR	22
4.2.2 LEVEL/LOSS INDICATOR	23
4.2.3 VIDEO IN/OUT INDICATORS	23
4.2.4 AUDIO 1, 2 IN/OUT INDICATORS	23

4.2.5	DATA 1, 2 IN/OUT INDICATORS.....	23
4.2.6	CONTACT 1, 2 IN/OUT INDICATORS	24
4.2.7	ENABLED 1, 2 INDICATORS.....	24
4.3	VIDEO TEST PATTERNS	24
4.4	TEST MODE	24
5	TROUBLESHOOTING	26
APPENDIX A: RS485 APPLICATION NOTES		27
A.1	INTRODUCTION	27
A.2	CONNECTION	27
A.3	CONFIGURATION	27
A.4	TERMINATION.....	27

BEFORE YOU BEGIN

Read these instructions before installing or operating this product.

Note: This installation should be made by a qualified service person and should conform to local codes.

This manual provides installation and operation information. To use this document, you must have the following minimum qualifications:

- A basic knowledge of CCTV systems and components
- A basic knowledge of electrical wiring and low-voltage electrical hookups

Intended use

Use this product only for the purpose for which it was designed; refer to the product specification and user documentation.

Customer Support

For assistance in installing, operating, maintaining, and troubleshooting this product, refer to this document and any other documentation provided. If you still have questions, please contact Technical Support and Sales:

GE Security

Call: 888 437-3287 (US, including Alaska and Hawaii; Puerto Rico; Canada)

Outside the toll-free area: 503 885-5700

www.gesecurity.com

Note: You should be at the equipment and ready with details before calling Technical Support.

Conventions Used in this Manual

Boldface or button icons highlight command entries. The following **WARNING**, **CAUTION**, and **Note** statements identify potential hazards that can occur if the equipment is handled improperly:



*** WARNING:**

Improper use of this equipment can cause severe bodily injury or equipment damage.



**** CAUTION:**

Improper use of this equipment can cause equipment damage.

Note: Notes contain important information about a product or procedure.

* This symbol indicates electrical warnings and cautions.

** This symbol indicates general warnings and cautions.

1 INTRODUCTION

This is a guide to the installation and operation of the S768DAV and S7768DAV series fiber optic video, audio, data, and contact closure transmission system. Please read the entire manual before installing the equipment.

NOTE: The series numbers S768DAVT and S768DAVR are used to describe all models of transmitters and receivers unless noted otherwise.

The Series S768DAV and S7768DAV transmission systems offer simultaneous real-time transmission of:

- One channel of two-way 9-bit digital video
- Two channels of two-way high quality audio (HQA)
- Two channels of two-way multi-protocol data (MPD)
- Two channels of two-way relay/contact closures

The S768DAV system operates over one or two multimode fibers and the S7768DAV uses one or two single-mode fibers. A complete system consists of an S768DAVT transmitter and an S768DAVR receiver. Units are designed for installation in the 515R1 or 517R1 Card Cages or in the 502R rack card enclosure. Figure 1 shows a basic system diagram.

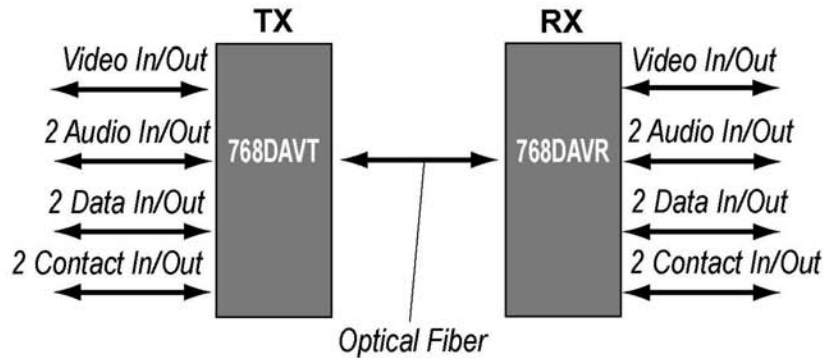

Figure 1. S768DAV System Diagram

2 MODULE SETUP

2.1 UNPACKING THE UNIT

In the event that anything is missing from the following list, contact your authorized dealer or representative.

- S768DAVT (S7768DAVT) Transmitter or S768DAVR (S7768DAVR) Receiver
- User Manual

Save the original packing materials in case it becomes necessary to return the unit.



CAUTION:

Take all necessary precautions to protect the unit from static electricity during the following procedures. Equipment damage may result.

2.2 DATA TRANSLATION

The data translation capability of the S768DAV series is unique in the industry. It enables translation from one data format to another and eliminates the need for external translation devices.

The translation is in the physical layer only; it cannot interpret specific protocols or translate commands. Due to the encoding schemes utilized in Manchester and Biphase, these formats are exempt from translation. Data translation examples are shown in Table 1.

Table 1. Data Translations

Translation	TX Switch Setting	RX Switch Setting	Comments
TTL to RS232 three-wire	3	1	Signal level conversion
RS232, three-wire to TTL	1	3	Signal level conversion
TTL to RS422	3	4	Single ended to differential conversion
RS422 to TTL	4	3	Differential to single ended conversion
RS232, three-wire to RS422	1	4	Single ended to differential conversion
RS422 to RS232, three -wire	4	1	Differential to single ended conversion
RS232, five-wire to RS485	2	7 - A	RS232 handshaking bit is used to indicate tri-state
RS485 to RS232, five-wire	7 - A	2	Tri-State detection circuitry activates handshaking bit

2.3 INPUT/OUTPUT DATA FORMAT

Determine the data formats required for input and output for both data channels. The data formats may be the same or different for each channel. The data format can also differ from input to output on the same data channel.

2.3.1 MANUAL DATA SELECTION

To set the data format for channels 1 and 2, see Figure 2, Figure 3, Table 2 and perform the following.

- 1) Select a data format for each Data channel on the transmitter using DATA SELECT switch SW1 (channel 1) and SW2 (channel 2).
- 2) Select a data format for each Data channel on the receiver using DATA SELECT switch SW1 (channel 1) and SW2 (channel 2).

NOTE: The DATA SELECT switches, SW1 and SW2 on the audio/data card, are shipped in the Auto Configure setting (position 0).

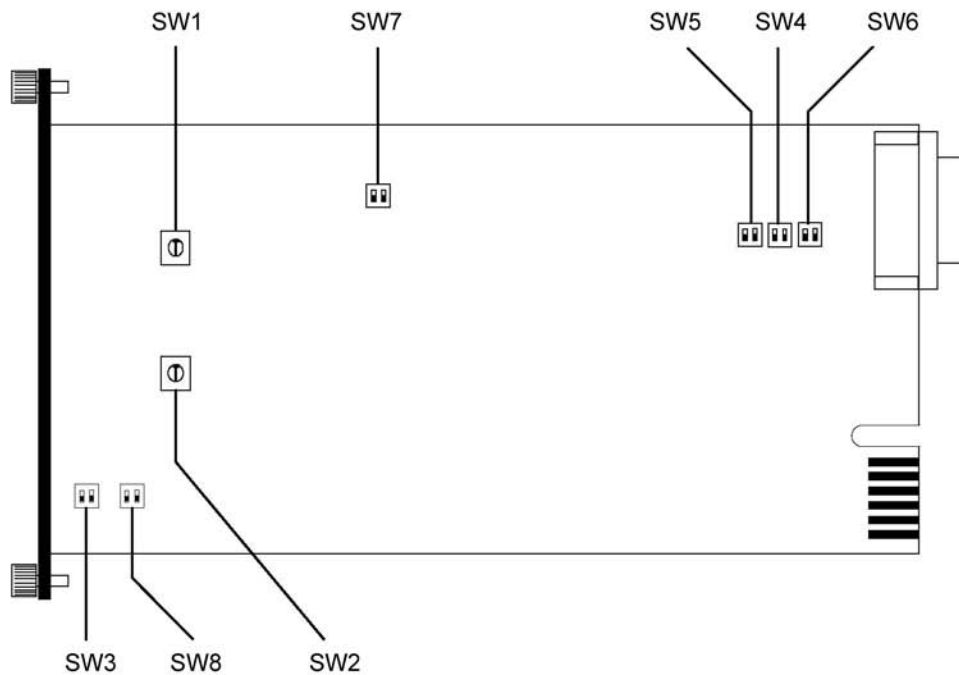
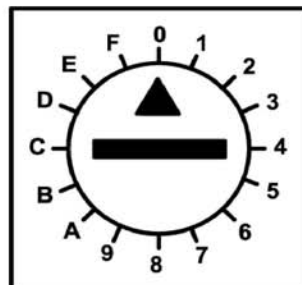

Figure 2. S768DAV Location of Switches



SW1 - DATA CHANNEL 1
 SW2 - DATA CHANNEL 2

Figure 3. DATA SELECT Switches SW1 and SW2

Table 2. DATA SELECT SW1/SW2 Settings

Setting	Data Mode	Setting	Data Mode
0	Not Configured or Auto Configuration	8	RS485 two -wire, 2V offset
1	RS232	9	RS485 four-wire standard
2	RS232 with handshake	A	RS485 four-wire, 1V offset
3	TTL	B	RS485 four-wire, 2V offset
4	RS422 two-wire	C	Not used
5	Manchester/Biphase	D	Not used
6	RS485 two-wire Standard or SensorNet	E	Receiver Test mode
7	RS485 two -wire, 1V offset	F	Transmitter Test mode

2.3.2 AUTO DATA CONFIGURATION

The S768DAV modules can be set for Auto Data Configuration, where the format of the data on channel 1 or channel 2 is controlled from one unit, either the transmitter or the receiver. To use the Auto Data Configuration feature, perform the following.

- 1) Set the DATA SELECT switches SW1 or SW2 on one unit to position 0 (default setting).
- 2) Set the DATA SELECT switches SW1 or SW2 on the other unit to the desired format.
- 3) If the data format needs to be changed for a particular channel, only the DATA SELECT switches on one unit need to be changed. The other unit remains in position 0 and will auto-configure according to the selected data format.

2.4 OPTICAL/VIDEO ALARMS

Rack cards are supplied with alarm functions that activate if the optical or video signal input to the module fails. These alarms can be output to the rack power supply, where an audible alarm and alarm output contact closure can be activated. The optical and video alarms are controlled using DIP switch SW3 on the audio/data card. To set the optical and video alarms, see Figure 2 and Figure 4 and perform the following.

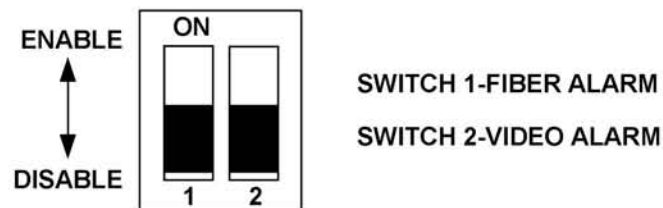

Figure 4. ALARM Switch SW3

- 1) Set switch SW3-1 to ON to enable the FIBER (optical) alarm.
- 2) Set SW3-2 to ON to enable the VIDEO alarm.

- 3) If the optical or video alarm output is not desired, set the corresponding DIP switch (SW3-1 or SW3-2) to OFF.

NOTE: Setting ALARM switches SW3-1 and SW3-2 to OFF does not affect the operation of the LEVEL/LOSS or VIDEO LEDs. A red LED always indicates signal loss.

2.5 VIDEO FORMAT/TEST PATTERN GENERATOR

The S768DAV links support both NTSC and PAL video standards without adjustment. DIP switch SW8 on the S768DAVT transmitter and S768DAVR receiver audio/data cards enable the test pattern generator and select the video format. To enable the test pattern generator and set the video format, see Figure 2 and Figure 5 and perform the following.

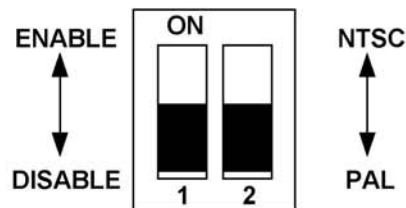

Figure 5. VIDEO FORMAT/TEST PATTERN GENERATOR Switch SW8

- 1) Set DIP switch SW8 on the transmitter and receiver to the desired position.
- 2) Ensure the switches on the transmitter and receiver are set to the same video format.

NOTE: In order for the test pattern generator to operate properly, both the transmitter and receiver must be set to the same format.

2.6 AUDIO LEVEL

The S768DAV system features dual audio level operation to meet the system requirements of -10 dBu audio reference and 0 dBu/+4 dBu audio reference level. All units are shipped with the audio level switches set to 18 dBu (0 dBu audio reference level). At this setting, the 18 dB of operating range will support maximum audio levels of +18 dBu. Switches SW4, SW5, and SW7 on the audio/data card select the input and output audio levels. To set the audio levels, see Figure 2 and Figure 6 and perform the following.

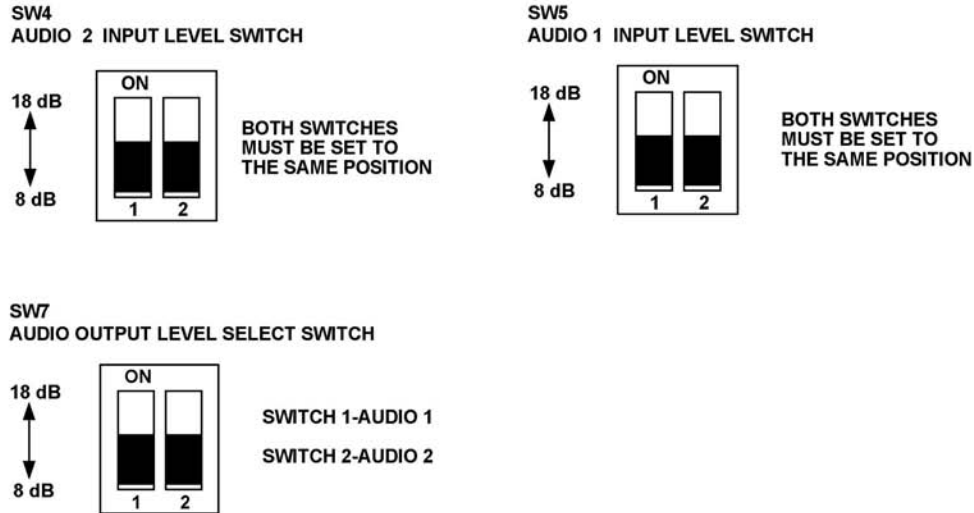

Figure 6. AUDIO LEVEL Switches SW4, SW5, and SW7

- 1) If a low audio input level causes the output audio signal to degrade, the input sensitivity of the S768DAV can be increased by switching to the 8 dBu maximum scale.
- 2) For systems running at -10 dBu, typical for VCRs and DVD players, switches SW4, SW5, and SW7 should be set to 8 dB.
- 3) You can set the transmitter input to 8 dBu and the receiver output to 18 dBu to add 10 dB of gain to the system, however, this also increases system signal-to-noise ratio (S/N).

2.7 INPUT IMPEDANCE

The S768DAV units are shipped with the input impedance set at high impedance (high-Z). To select a 600Ω input impedance in place of the high-Z input, set switch SW6 on the audio/data card to 600. See Figure 2 and Figure 7.

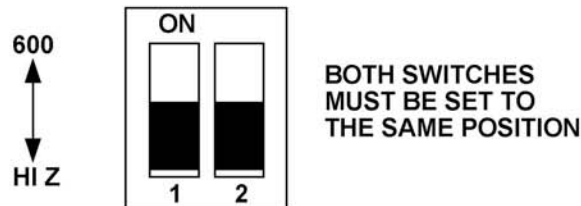

Figure 7. IMPEDANCE Switch SW6

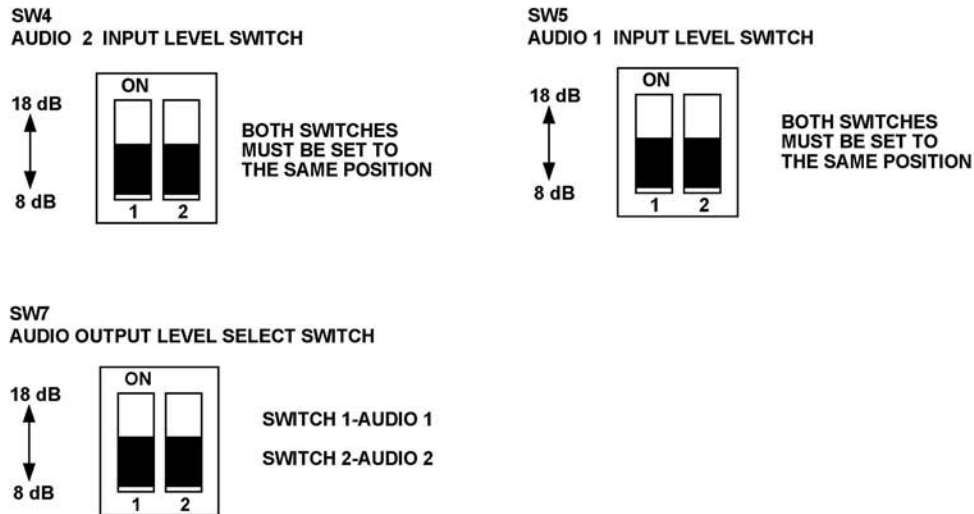

Figure 6. AUDIO LEVEL Switches SW4, SW5, and SW7

- 1) If a low audio input level causes the output audio signal to degrade, the input sensitivity of the S768DAV can be increased by switching to the 8 dBu maximum scale.
- 2) For systems running at -10 dBu, typical for VCRs and DVD players, switches SW4, SW5, and SW7 should be set to 8 dB.
- 3) You can set the transmitter input to 8 dBu and the receiver output to 18 dBu to add 10 dB of gain to the system, however, this also increases system signal-to-noise ratio (S/N).

2.7 INPUT IMPEDANCE

The S768DAV units are shipped with the input impedance set at high impedance (high-Z). To select a 600Ω input impedance in place of the high-Z input, set switch SW6 on the audio/data card to 600. See Figure 2 and Figure 7.

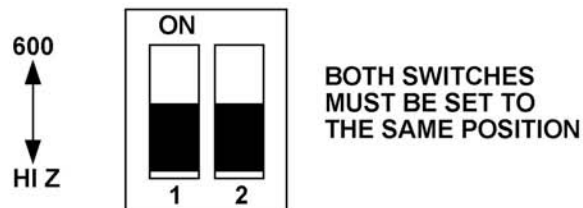

Figure 7. IMPEDANCE Switch SW6

3 INSTALLATION

This fiber-optic link is supplied as a rack card. The rack cards can also be used in a standalone configuration if placed in a 502R rack card enclosure.

Units should be installed in dry locations protected from extremes of temperature and humidity.

3.1 RACK CARDS

Rack cards are installed in a 19-inch (483-mm), EIA standard card-cage rack, either the 515R1 or the 517R1. Follow these guidelines to install rack cards.



CAUTION:

Although rack cards are hot-swappable and can be installed without turning off power to the rack, the power switch on the rack power supply should be turned off and the rack power supply disconnected from any power source before installing rack cards.

-
- 1) Make sure that the card is oriented right-side up, and slide it into the card guides in the rack until the edge connector at the back of the card seats in the corresponding slot in the rack's connector panel. Seating may require thumb pressure on the top and bottom of the card's front panel.



CAUTION:

Do not press on any of the LEDs when installing cards into the rack. Equipment damage may result.

-
- 2) Tighten the two thumbscrews on the card until the front panel of the card is seated against the front of the rack.

3.2 502R RACK CARD ENCLOSURES

To install rack cards in the 502R rack card enclosure, see Figure 8 and perform the following.



CAUTION:

The rack card module can be powered only by 13.5 - 16 VDC. AC power must not be used. It is recommended that the 613P power adapter be used to supply power to the module. Damage to the equipment may result if AC power is used.



CAUTION:

Complete all instruction steps before supplying power to the unit.

- 1) Look inside the enclosure to determine the location of the socket for the edge connector on the card. Orient the card so that it will seat in the socket, and slide it into the card guides in the enclosure until the edge connector at the back of the card seats in the socket. Seating may require thumb pressure on the top and bottom of the card's front panel.

**CAUTION:**

Do not to press on any of the LEDs when installing cards into the enclosure. Equipment damage may result.

- 2) Tighten the two thumbscrews on the card until the front panel of the card is seated against the front of the enclosure.
- 3) Determine where the module will be installed, and ensure that there is adequate space for making the various cable connections and for reading the diagnostic LEDs.

NOTE: The type of screws chosen must be suitable for the surface on which the module is to be mounted.

- 4) Standalone modules can be attached to suitable flat surfaces with four No. 6 (3 mm) screws. After the enclosure is securely attached to a flat surface, the cable connections can be made.

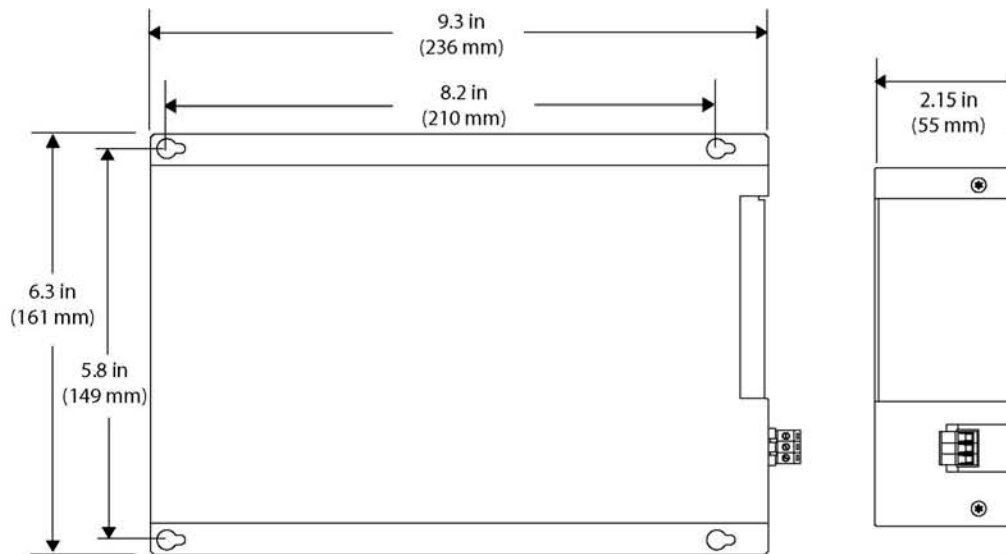

Figure 8. 502R Rack Card Enclosure Mounting Data

3.3 CONNECTIONS

All video, audio, data, contact, and fiber connections are made to the back panel of the S768DAV module. When connecting audio, data, or contact signals, always wire the signal OUT pins on the audio/data equipment to the signal IN pins on the fiber links, and the signal IN pins on the audio/data equipment to the signal OUT pins on the fiber links. See Figure 9.

Table 3. J4 Audio/Data Connections

Pin	Signal	Pin	Signal
1	AUDIO CHANNEL 1 OUT +	14	AUDIO CHANNEL 1 IN -
2	GROUND	15	AUDIO CHANNEL 2 IN +
3	AUDIO CHANNEL 2 OUT -	16	GROUND
4	CONTACT CHANNEL 1 IN +	17	DATA CHANNEL 1 OUT -
5	AUDIO CHANNEL 1 IN +	18	DATA CHANNEL 1 IN -
6	AUDIO CHANNEL 2 IN -	19	CONTACT CHANNEL 2 OUT -
7	DATA CHANNEL 1 OUT +	20	CONTACT CHANNEL 1 OUT +
8	DATA CHANNEL 1 IN +	21	CONTACT CHANNEL 1 OUT -
9	DATA CHANNEL 2 IN -	22	+5 VDC BIAS
10	CONTACT CHANNEL 2 OUT +	23	GROUND
11	AUDIO CHANNEL 1 OUT -	24	DATA CHANNEL 2 OUT +
12	AUDIO CHANNEL 2 OUT +	25	DATA CHANNEL 2 OUT -
13	CONTACT CHANNEL 2 IN +	26	DATA CHANNEL 2 IN +

3.3.2 INTERFACE BOARD CONNECTIONS

The S768DAV units are also supplied with an interface board that attaches directly to the back of the module. The interface board contains screw terminal connectors for the audio, data, and contact inputs and outputs. Refer to Figure 11 and Table 4 through Table 14 for interface board wiring information.

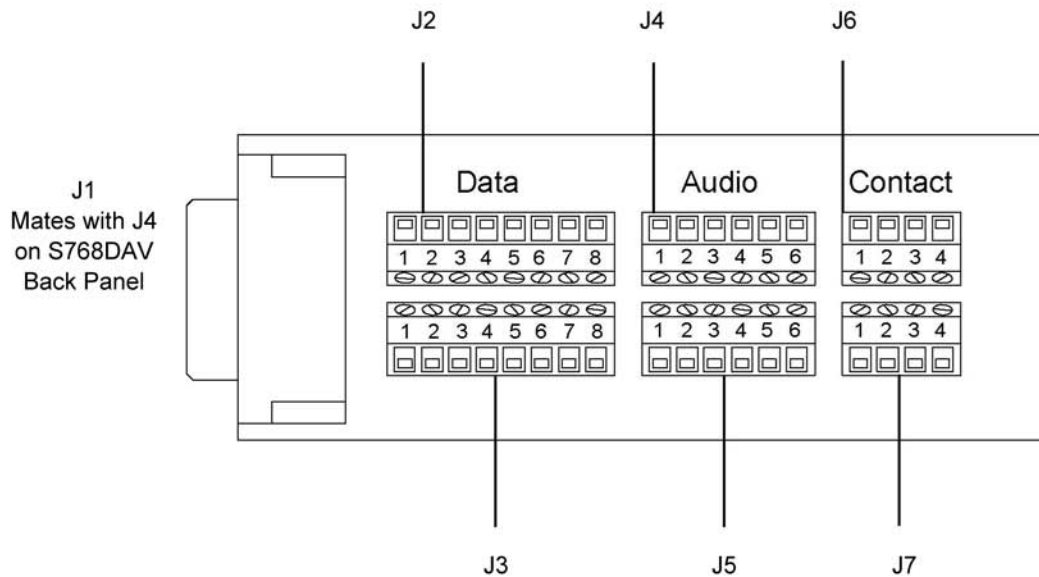

Figure 11. S768DAV Interface Board

Table 4. Interface Board Connections

Pin	Signal	Pin	Signal
Connector J2		Connector J3	
1	GROUND	1	GROUND
2	DATA CHANNEL 1 OUT +	2	DATA CHANNEL 2 OUT +
3	DATA CHANNEL 1 OUT -	3	DATA CHANNEL 2 OUT -
4	+5 VDC BIAS	4	+5 VDC BIAS
5	DATA CHANNEL 1 IN +	5	DATA CHANNEL 2 IN +
6	DATA CHANNEL 1 IN -	6	DATA CHANNEL 2 IN -
7	TERMINATION	7	TERMINATION
8	GROUND	8	GROUND
Connector J4		Connector J5	
1	AUDIO CHANNEL 1 IN +	1	AUDIO CHANNEL 2 IN +
2	AUDIO CHANNEL 1 IN -	2	AUDIO CHANNEL 2 IN -
3	GROUND	3	GROUND
4	AUDIO CHANNEL 1 OUT +	4	AUDIO CHANNEL 2 OUT +
5	AUDIO CHANNEL 1 OUT -	5	AUDIO CHANNEL 2 OUT -
6	GROUND	6	GROUND
Connector J6		Connector J7	
1	CONTACT CHANNEL 1 IN +	1	CONTACT CHANNEL 2 IN +
2	CONTACT CHANNEL 1 IN -	2	CONTACT CHANNEL 2 IN -
3	CONTACT CHANNEL 1 OUT +	3	CONTACT CHANNEL 2 OUT +
4	CONTACT CHANNEL 1 OUT -	4	CONTACT CHANNEL 2 OUT -

Table 5. J2/J3 Connections for RS232 Data

SW1 / SW2 – Position 1	
Pin	Signal
1	GROUND/SHIELD
2	RS232 OUT
3	NO CONNECTION
4	NO CONNECTION
5	RS232 IN
6	NO CONNECTION
7	NO CONNECTION
8	GROUND

Table 6. J2/J3 Connections for RS232 Data with Handshaking

SW1 / SW2 – Position 2	
Pin	Signal
1	GROUND/SHIELD
2	RS232 OUT
3	RTS/CTS OUT
4	NO CONNECTION
5	RS232 IN
6	RTS/CTS IN
7	NO CONNECTION
8	GROUND

Table 7. J2/J3 Connections for TTL Data

SW1 / SW2 – Position 3	
Pin	Signal
1	GROUND/SHIELD
2	NO CONNECTION
3	TTL OUT
4	NO CONNECTION
5	TIE TO PIN 1
6	TTL IN
7	NO CONNECTION
8	GROUND

Table 8. J2/J3 Connections for RS422 Data

SW1 / SW2 – Position 4	
Pin	Signal
1	GROUND/SHIELD
2	RS422 OUT -
3	RS422 OUT +
4	NO CONNECTION
5	RS422 IN -
6	RS422 IN +
7	NO CONNECTION
8	GROUND

Table 9. J2/J3 Connections for Manchester/Biphase Data

SW1 / SW2 – Position 5	
Pin	Signal
1	MANCHESTER/BIPHASE OUT -
2	MANCHESTER/BIPHASE OUT +
3	NO CONNECTION
4	NO CONNECTION
5	MANCHESTER/BIPHASE IN -
6	MANCHESTER/BIPHASE IN +
7	NO CONNECTION
8	GROUND

Table 10. J2/J3 Connections for Manchester/Biphase Termination Unit Data

SW1 / SW2 – Position 5	
Pin	Signal
1	MANCHESTER/BIPHASE OUT -
2	MANCHESTER/BIPHASE OUT +
3	NO CONNECTION
4	NO CONNECTION
5	MANCHESTER/BIPHASE IN -
6	MANCHESTER/BIPHASE IN +
7	TERMINIATION - TIE TO PIN 5
8	GROUND

Table 11. J2/J3 Connections for RS485 2-Wire Data

SW1 / SW2 – Position 6 (standard offset) Position 7 (1V offset) Position 8 (2V offset)	
Pin	Signal
1	GROUND/SHIELD
2	NO CONNECTION
3	NO CONNECTION
4	+5 VDC BIAS OUT
5	RS485 -
6	RS485 +
7	TERMINATION – TIE TO PIN 5
8	GROUND

Table 12. J2/J3 Connections for RS485 4-Wire Data

SW1 / SW2 – Position 9 (standard offset) Position A (1V offset) Position B (2V offset)	
Pin	Signal
1	GROUND/SHIELD
2	RS485 OUT -
3	RS485 OUT +
4	+5 VDC BIAS OUT
5	RS485 IN -
6	RS485 IN +
7	TERMINATION – TIE TO PIN 5
8	GROUND

Table 13. J2/J3 Connections for SensorNet Data

SW1 / SW2 – Position 6	
Pin	Signal
1	GROUND/SHIELD
2	NO CONNECTION
3	NO CONNECTION
4	+5 VDC BIAS OUT
5	SENSORNET -
6	SENSORNET +
7	TERMINATION – TIE TO PIN 5
8	GROUND

Table 14. J2/J3 Connections for Test Mode Loopback

SW1 / SW2 – Position F	
Pin	Signal
1	NO CONNECTION
2	TIE TO PIN 5
3	TIE TO PIN 6
4	NO CONNECTION
5	TIE TO PIN 2
6	TIE TO PIN 3
7	NO CONNECTION
8	GROUND

3.3.3 BUILT-IN TERMINATION

The S768DAV features a built-in termination on the Interface Board for RS485, Manchester, Biphase, and SensorNet installations. Refer to Table 4, and Table 10 through Table 13.

3.3.4 VIDEO CABLE CONNECTIONS



CAUTION:

Make sure all peripheral equipment that will be connected to the fiber unit is turned OFF during installation. Damage to equipment may result.

NOTE: Belden number 9259 or equivalent RG59/U coaxial cable should be used between the video equipment and the fiber units. Do not exceed the maximum distance recommended by the manufacturer of the video equipment.

NOTE: Coaxial cable must be terminated with female BNC connectors to properly connect with the fiber links.

Connect the video equipment, such as a camera and monitor, to the input and output BNC jacks on the S768DAV transmitter and receiver using terminated coaxial cable. See Figure 10.

3.3.5 AUDIO CONNECTIONS

Audio input and output signals are connected to the 26-pin connector located on the back of the module, or to the screw terminal connectors on the Interface board supplied with the unit. See Figure 10 and Figure 11. Refer to Table 3 and Table 4 for wiring information.

NOTE: Signal strength remains the same regardless of type of connection.

Audio connection options include:

- Balanced transmitter input to balanced receiver output
 - Balanced transmitter input to unbalanced receiver output
 - Unbalanced transmitter input to unbalanced receiver output
 - Unbalanced transmitter input to balanced receiver output
- 1) For a balanced connection, connect the external equipment to the (+) and (-) pins of the desired channel.
 - 2) For an unbalanced connection, add a short jumper between the (-) pin and the ground pin.

3.3.6 FIBER OPTIC CABLE CONNECTIONS

Most cable manufacturers identify the individual fibers in the cable. Select appropriately terminated fiber and mark both ends with a unique identification label (e.g. for cable no. 03, fiber no. 08) to ensure that the fiber connected to the near end is the same as the one connected to the far end.

The proper optical connection will link the transmitter's TRANSMIT (OUT) port to the receiver's RECEIVE (IN) port. See Figure 10.

- 1) Wipe the inside of the port's sleeve with a lint-free pipe cleaner moistened with reagent-grade isopropyl alcohol. Blow dry with dry air.
- 2) Clean the connector using a lint-free cloth dampened with reagent-grade isopropyl alcohol. Thoroughly wipe the side and end of the ferrule. Blow the ferrule dry with dry air. Visually inspect the ferrule for lint.
- 3) Fasten the fiber optic cable to the port.

3.3.7 STANDALONE MODULE POWER CONNECTIONS

**CAUTION:**

Standalone modules can be powered only by 13.5 - 16 VDC. AC power must not be used. Damage to the equipment will result.

The 502R rack card enclosure has a removable screw terminal connector for the electrical input connection. Pin 1 of this connector is the GROUND terminal, pin 2 is not used, and pin 3 is the +DC terminal as marked on the enclosure. Connect the input power as follows.

- 1) Identify the power connector and remove it from the module.
- 2) Make sure the power supply is not connected to any power source, and strip approximately 0.25 inches (6 mm) of insulation from the ends of the cable.
- 3) Taking care to observe the correct polarization of the cable, insert one lead into one of the screw sockets and tighten the screw. Confirm the security of the connection with a light pull on the cable.
- 4) Repeat step 3 for the other conductor.
- 5) Seat the connector in its position in the fiber unit.
- 6) Plug the power supply into a suitable outlet.
- 7) Power up the peripheral equipment and verify system operation by observing video on the monitor at the receiver end.

3.3.8 RACK MODULE POWER CONNECTIONS

Power connections are made automatically when the card is installed. To supply power to the rack, connect the rack power supply to an AC outlet and set the power switch to ON.

NOTE: To provide earth ground reference, Stand Alone (Enclosure) modules need to be connected to a good earth ground. This can be accomplished by connecting a copper-based conductor from the modules DC Common/Ground pin to an approved earth ground.

4 OPERATION

4.1 NORMAL OPERATION

S768DAV fiber links operate automatically after installation. Refer to paragraph 4.4 for details on how to execute the test mode. For description of LED color codes and an explanation of how to diagnose system faults using the LEDs built into the units, refer to section 5, Troubleshooting.

4.2 LED OPERATION

The S768DAV modules have built-in Status Monitoring And Reliability Test System (SMARTS™) diagnostic capabilities that include LED indicators for monitoring data and optical status. The S768DAV fiber units have nine pairs of LED indicators that describe the current state of operation; the current status of video, audio, and data signals; and fiber optic signal strength.

These indicator pairs are LASER and LEVEL/LOSS, VIDEO IN/OUT, AUDIO 1 IN/OUT, AUDIO 2 IN/OUT, DATA 1 IN/OUT, DATA 2 IN/OUT, CONTACT 1 IN/OUT, CONTACT 2 IN/OUT, ENABLED 1, and ENABLED 2. See Figure 12. The operation of the front panel LEDs is described in the following paragraphs.

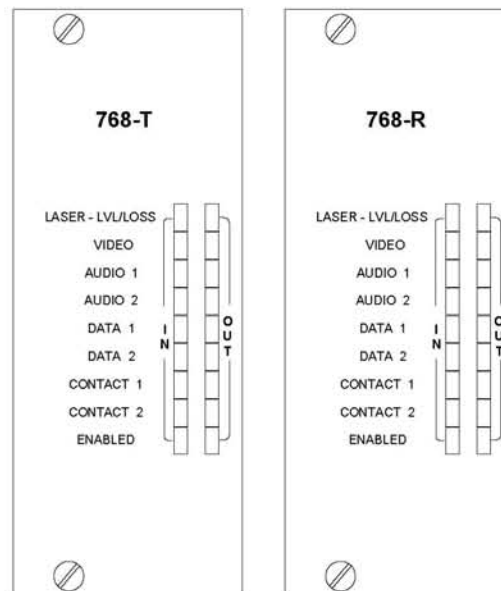

Figure 12. Front Panel LEDs

4.2.1 LASER INDICATOR

A green LASER LED indicates the laser is operating normally. A red LASER LED indicates the laser is malfunctioning.

4.2.2 LEVEL/LOSS INDICATOR

This LED indicates the relative optical signal strength received at the module. When sufficient optical power is being received, the LED is green. As the optical power decreases, as happens through long fiber runs, splices or connections, the LEVEL/LOSS LED stays green until the optical power drops below the minimum level.

The LEVEL/LOSS LED will turn bright red to indicate an insufficient amount of optical power is being received. All data will default to its failure state level to eliminate bus contention.

4.2.3 VIDEO IN/OUT INDICATORS

The VIDEO IN (or OUT) LED indicates the strength of the video signal. The VIDEO IN LED on the module remains green as long as an adequate video signal is being input to the unit. If the video input becomes too weak, the LED will turn red. The VIDEO OUT LED on the module performs a similar function, except that it refers to the video output from the unit.

Note: The S768DAV monitors the video sync signals to determine the strength of the signal. It does not monitor the brightness signal. Thus, if the scene in front of a camera is totally dark, producing a blank monitor screen, the VIDEO IN and OUT LEDs can still be green.

4.2.4 AUDIO 1, 2 IN/OUT INDICATORS

The AUDIO IN (or OUT) LED indicates the strength of the audio signal by varying in intensity. The AUDIO IN LED remains green as long as an adequate audio signal level is being input to the module.

If the audio input becomes too weak, the LED will turn off. The LED will be red when the audio level is clipped.

The AUDIO OUT LED performs a similar function, except that it refers to the audio output from the module.

4.2.5 DATA 1, 2 IN/OUT INDICATORS

The DATA IN LED indicates the level of the data signal being input to the S768DAV over copper. A green DATA IN LED indicates a logic HIGH is present on the data inputs.

An amber DATA IN LED indicates a logic LOW is present on the copper. No color (OFF) indicates a tri-state or high impedance input.

This LED can be used to determine the resting state of your equipment and, in the RS485 states, verify that a tri-state is being detected properly.

The S768DAV has special circuitry to capture data transitions and make them visible on the LEDs. High-speed bursts of activity, previously undetectable by standard LED circuits, are easily seen by this special circuitry.

The DATA OUT LED functions identically to the DATA IN LED except that the LED represents data that is being output from the unit. This LED has the same high-speed capture circuitry as the DATA IN LED.

4.2.6 CONTACT 1, 2 IN/OUT INDICATORS

The CONTACT IN/OUT LEDs indicate the presence of relay/contact closure signals. A green CONTACT IN/OUT LED indicates a closed relay contact, and a red LED indicates an open relay contact.

4.2.7 ENABLED 1, 2 INDICATORS

The ENABLED 1 (left) and ENABLED 2 (right) LEDs monitor the selected mode of Data channels 1 and 2. They have five states as follows:

- Green indicates a valid mode has been selected.
- Red indicates an invalid mode (spare or TEST mode) has been selected.
- Flashing red/green indicates that no mode has been selected.
- Flashing green/off indicates a valid mode is configured remotely.
- Flashing red/off indicates either an invalid mode or the Test mode is configured remotely.

4.3 VIDEO TEST PATTERNS

The S768DAV includes an internal video test pattern generator that can ease installation and troubleshooting. The test patterns generated can notify the user of a fiber or video source failure by outputting specific test patterns on the user's monitor. This mode verifies proper functionality of the digital decoding process and the fiber-optic interconnections.

Follow the procedures described in paragraph 2.5 to enable the test pattern generator. Figure 13 shows the test patterns displayed on the monitor.

Disabling the test pattern generator causes no on-screen display during failure conditions.

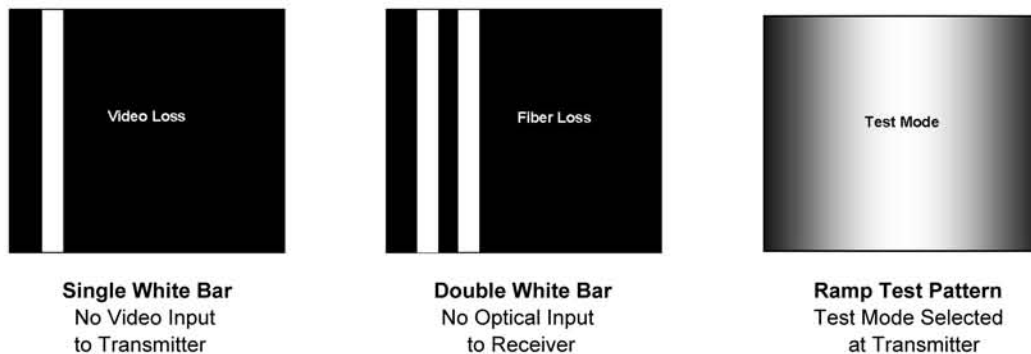

Figure 13. On-Screen Monitor Displays

4.4 TEST MODE

The Test mode enables you to verify the operation of the video, audio, and data circuits in the S768DAV units, as well as the fiber connection from the S768DAV transmitter to the S768DAV receiver. To execute the test mode, perform the following.

Note: Either DATA SELECT switch (SW-1 or SW-2) can be set to position F to enable the video ramp test pattern and the 1 kHz test tone generator to verify video and audio operation.

- 1) Set the DATA SELECT switch on the S768DAV you are testing to F (TX Test Mode). At this end only, wire the data connections as follows (refer to Table 14):
 - Connect the DATA IN+ pin to the DATA OUT+ pin.
 - Connect the DATA IN- pin to the DATA OUT- pin.
- 2) At the opposite end, set the DATA SELECT switch on the S768DAV to E (RX Test Mode).
- 3) The transmitting unit should operate as follows:
 - ENABLED LED is RED, indicating that a valid data format has not been selected.
 - DATA OUT LED is slowly flashing between amber, green, and off. This indicates that the test mode is generating an output pattern and sending it out on copper.
 - DATA IN LED should mimic the DATA OUT LED. This indicates a good, proper loopback connection, and proves that the data transmit/receive circuitry is working properly.
 - LEVEL/LOSSTM might be red or green indicating received fiber signal strength.
- 4) The receiving unit should operate as follows:
 - ENABLED LED is GREEN indicating a valid data format is selected.
 - DATA OUT LED should slowly flash amber, green, off. This indicates that the fiber path from the unit set for Test mode is reliable.
 - DATA IN LED should be OFF indicating there is no input copper connection made.
 - LEVEL/LOSS LED should be green to off (but not red), indicating that sufficient optical power is being received.
 - The AUDIO OUT LEDs should be green indicating sufficient audio output signal level.
- 5) In addition to the LED operation described above, verify the following:
 - The monitor displays a ramp test pattern as shown in Figure 13.
 - A 1 kHz test tone is emitted on the audio system connected to the receiving unit.

After the test has been performed at one end, swap switch positions and connectors to perform the test on the other end. If the test is successful, the copper-in-to-fiber-to-copper-out conversion is working in both directions.

5 TROUBLESHOOTING

Table 15 contains troubleshooting information for the S768DAV units.

Table 15. Troubleshooting

Problem	Probable Cause	Solution
Red LASER LED	Laser is malfunctioning	Replace module
Red LEVEL/LOSS LED	Fiber not connected	Connect fiber to receiver and transmitter
	Transmitter/Receiver not powered up	Connect and apply power to module
VIDEO IN/OUT LED is OFF	Video input not connected to module	Connect video input to module
	Video source not powered up	Apply power to video source
	Video source not transmitting	Check video source and cabling
AUDIO IN/OUT LED is OFF	Audio input not connected to module	Connect audio input to module
	Audio source not powered up	Apply power to audio source
	Audio source not transmitting	Check audio source and cabling
DATA IN LED is OFF	Tri-state condition	No action required
	Data input not connected to module	Connect data input to module
	Data source not powered up	Apply power to data source
	Data source not transmitting	Check data source and cabling
Red ENABLED 1 and/or 2 LED	Test or invalid mode selected	Set DATA SELECT switch to valid format
ENABLED 1 and/or 2 LED flashing red/green	Both Transmitter and Receiver set to Auto Configure mode	Set Transmitter or Receiver DATA SELECT switch to valid format
ENABLED 1 and/or 2 LED flashing red/off	Invalid or Test mode configured remotely	Set DATA SELECT switch to valid format if not in Test mode

APPENDIX A: RS485 APPLICATION NOTES

A.1 INTRODUCTION

The S768DAV is configurable for both full-duplex (four-wire) and half-duplex (two-wire) operation. It can be used for interfacing to systems adhering strictly to the RS-485 specification and for use with systems that use a modified, "fail-safe biased" RS-485 bus.

A.2 CONNECTION

Use high-quality twisted-pair wiring, and make sure all connection points are clean and tight. A loose connection on one of the wires can appear to function, yet cause intermittent errors: DATA LEDs may be flashing as signals pass through the system, but those signals will be corrupt.

A.3 CONFIGURATION

The S768DAV multi-protocol data (MPD) units are designed to work with virtually any RS485 system. Unfortunately, some systems operate on a "modified" version of RS485 that use a fail-safe biasing to pull up/down their bus during a tri-state condition. In a standard RS485 system, when a driver on a properly terminated bus goes into tri-state, the voltage between the differential outputs should be less than 200 mv.

(This is considered "standard offset" in the product instruction manuals.) A differential output tri-state voltage this small can cause some non-standard systems to latch up, because they are designed for much larger, "fail-safe," offsets.

To be able to interface to such equipment, the S768DAV MPD units offer two more "offset" level modes. In most cases, the S768DAV unit should be configured for "standard offset" operation.

When the system is operating properly, the DATA IN and DATA OUT LEDs are off when there is no communication (tri-state) and flash when data is being sent or received. If the link is not functioning properly (LEDs will most likely not turn off), change the DATA SELECT switch on the unit to a higher offset mode.

First try 1 V, then 2 V. If switching the mode switch does not prove effective, the offset level may have to be emulated at one end of the system by using pull-up/down resistors on the data connector. The S768DAV has a +5 V bias pin and ground pins on the connector for this purpose. Contact the equipment manufacturer's technical support for recommended resistor values and configuration.

A.4 TERMINATION

RS485 systems need to be properly terminated in order to work reliably. Two terminating resistors are used on each RS485 bus, at the farthest ends of the link.

These resistors should be attached to the data/audio connector on the back of the unit if the S768DAV link is at one end of the bus. If the terminating resistors are left out, the tri-state condition will not be detected, and the bus might lock up. If there are too many terminations on the bus, signal levels might

Customer Support

For assistance in installing, operating, maintaining, and troubleshooting this product, refer to this document and any other documentation provided. If you still have questions, please contact technical support during normal business hours (Monday through Friday, excluding holidays, between 6 a.m. and 5 p.m. Pacific Time).

GE Security

Call: 888 437-3287 (US, including Alaska and Hawaii; Puerto Rico; Canada)

Outside the toll-free area: 503 885-5700

Fax: 561 998-6224

www.gesecurity.com



GE Security

www.GESecurity.com

U.S.

T (561) 998-6100

T 888-GE-SECURITY
888 (437-3287)

F 561 998-6224

E gesecuritycustserv@ge.com

Asia

T 852-2907-8108

F 852-2142-5063

Australia

T 613-9239-1200

F 613-9239-1299

Canada

T 519-376-2430

F 519-376-7258

Europe

T 44-113-238-1668

F 44-113-253-8121

Latin America

T 305-593-4301

F 305-593-4300